

MODEL 384
**MAY BE INSTALLED IN A SOLID FUEL BURNING FIREPLACE, AS A
FREESTANDING FIREPLACE, AS A ZERO CLEARANCE FIREPLACE OR
WITH AN OPTIONAL WOODEN SURROUND**



VENT-FREE

DISCLAIMER 
TRIM KITS NOT INCLUDED | SOLD SEPARATE

WARNING: If the information in this manual is not followed exactly, a fire or explosion may result causing property damage, personal injury or loss of life.

- Do not store or use gasoline or other flammable vapors and liquids in vicinity of this or any other appliance.

WHAT TO DO IF YOU SMELL GAS:

- Do not try to light any appliance.
- Do not touch any electrical switch; do not use any phone in your building.
- Immediately call your gas supplier from a neighbor's phone. Follow gas supplier's instructions.
- If you cannot reach your gas supplier, call fire department.
- Installation and service must be performed by a qualified installer, service agency or gas supplier.

This is an unvented gas-fired heater. It uses air (oxygen) from room in which it is installed. Provisions for adequate combustion and ventilation air must be provided. Refer to section "Producing Adequate Air For Combustion And Ventilation" page 31.

This appliance may be installed in an aftermarket, permanently located, manufactured (mobile) home, where not prohibited by local codes.

This appliance is only for use with type of gas indicated on rating plate. This appliance is not convertible for use with other gases.

INSTALLER: Leave this manual with appliance.
CONSUMER: Retain this manual for future reference.

MANUFACTURED BY:
NEW BUCK CORPORATION
200 ETHAN ALLEN DRIVE
PO BOX 69
SPRUCE PINE, N.C. 28777
www.buckstove.com

This appliance is intended for supplemental heating.



Revised August 2024

TABLE OF CONTENTS

SECTION I: Safety Information.....	1
SECTION II: Fireplace Preparation.....	4
Fireplace Clearances	5
Gas Connection.....	5
Placement of Logs.....	6
Gas Pressure Check.....	7
Lighting Instructions - SIT Millivolt Valve.....	8
Flame Check	12
Heat Output.....	12
Wiring Diagram	13
SECTION III: Solid Fuel Burning Fireplace Installation (FP).....	15
SECTION IV: Wooden Surround Installation (WS)	17
SECTION V: Zero Clearance Installation (ZC)	19
SECTION VI: Freestanding Installation (FS).....	23
Leg Installation	24
SECTION VII: Alcove Installation	25
SECTION VIII: Producing Adequate Air For Combustion And Ventilation.....	26
SECTION IX: Air For Combustion and Ventilation Inside	28
SECTION X: Air For Combustion and Ventilation Outdoors.....	29
SECTION XI: Installation-After Market Permanently Located Manufactured Home.....	30
Important Safeguards	31
Cleaning	31
Trouble Shooting	32
Service and Repair Parts	36
Replacement Parts.....	37
Warranty/Owner Registration.....	39

SECTION I

SAFETY INFORMATION WARNINGS

IMPORTANT: READ THIS OWNER'S MANUAL CAREFULLY AND COMPLETELY BEFORE TRYING TO ASSEMBLE, OPERATE, OR SERVICE APPLIANCE. IMPROPER USE OF THESE LOGS CAN CAUSE SERIOUS INJURY OR DEATH FROM BURNS, FIRE, EXPLOSION AND CARBON MONOXIDE POISONING.

- **NOTE: When burning any unit or appliance that combusts fuel for heat, such as coal, oil, wood or natural and (L.P.) liquid petroleum gas, we highly recommend use of smoke and carbon monoxide detectors in your home.**

Early signs of carbon monoxide poisoning resemble flu, with headaches, dizziness and/or nausea. If you have these signs, heater may not be working properly. Get fresh air at once! Have heater serviced.

Some people-pregnant women, persons with heart or lung disease, anemia, those under influence of alcohol and those at high altitudes-are more affected by carbon monoxide than others.

CAUTION: Strong drafts, such as a ceiling fan placed directly in front of heater (pulling from either direction) may create sooting. Sooting will discolor walls.

1. The installation must conform with local codes or in the absence of local codes, with *National Fuel Gas Code, ANSI Z223.1/NFPA54*.
2. **This appliance may be installed in an After-Market* Manufactured (Mobile) Home, where not prohibited by state or local codes.**
(After-Market: Completion of sale, not for purpose of resale from manufacturer.)

**This appliance is only for use with the type of gas indicated on rating plate.
This appliance is not convertible for use with other gases.**

NOTE:See Section VIII, "Producing Adequate Air For Combustion And Ventilation" page 31.

IMPORTANT: VENT-FREE HEATERS ADD MOISTURE TO AIR. ALTHOUGH THIS IS BENEFICIAL, INSTALLING HEATER IN ROOMS WITHOUT ADEQUATE VENTILATION MAY CAUSE MILDEW TO FORM FROM TOO MUCH MOISTURE.

3. Never install this heater:
 - In a recreational vehicle, bathroom, bedroom or any other sleeping quarters.
 - Where curtains, furniture, clothing or other flammable objects are less than 42" from front of heater
 - In high traffic areas or in windy areas
4. Two models are available. One specific model for propane (LP) and one for natural gas. Use the correct type gas for your home. Do not convert from one gas type to another.

NOTE: This appliance complies with ANSI Z21.11.2-Unvented Room Heater.

WARNING: ANY CHANGE TO THIS HEATER OR ITS CONTROLS CAN BE DANGEROUS.

5. If this heater is used with propane gas, do not place propane supply tank(s) inside any structure.
6. **What To Do IF You Smell Gas:**
 - Shut off gas supply.
 - Do not try to light any appliance.
 - Do not touch any electrical switch; do not use any phone in your building.
 - Immediately call your gas supplier from a neighbor's phone. Follow gas supplier's instructions.
 - If you cannot reach your gas supplier, call fire department.
7. When operated for first time, logs may emit a "paper burning" smell. This smell will gradually diminish and will be totally eliminated after first few hours of operation. Run gas logs with flue damper open during this time. Do not use blower at this time.
8. This heater shall not be installed in unusually tight construction unless provisions are provided for adequate combustion and ventilation air. See *Producing Adequate Air For Combustion And Ventilation, page 31*.
9. Surface of gas logs becomes very hot when operating. Keep children and adults away from hot surface. Gas logs will remain hot for sometime after shutdown. Allow surface to cool before touching.
10. Do not place clothing or other flammable material on or near appliance.
11. If equipped, fresh air damper must be closed.
12. Keep appliance area clean and free from combustible materials, gasoline and other flammable vapors and liquids.
13. If burner shuts off, do not relight until you provide fresh outside air. If burner continues to shut off, have unit serviced.
14. Do not use this heater if any part has been under water. Immediately call a qualified service technician to inspect room heater and to replace any part of control system and any gas control which has been under water.
15. Turn off heater and let cool before servicing.
16. These logs are made of bonded fiber. When removing logs and base, do not damage the bonded material. If material is damaged extensively, loose fiber dust could be emitted into air.
17. Any safety screen or guard removed for servicing an appliance must be replaced prior to operating heater.
18. This appliance is intended for supplemental heating.
19. **WARNING:** Any change to this heater or its controls can be dangerous.
20. Installation and repairs should be performed by a qualified service person. The appliance should be inspected before use and at least annually by a professional service person. More frequent cleaning may be required due to excessive lint from carpeting, bedding material, etc. It is imperative that control compartments, burners and circulating air passageways of appliance be kept clean.

21. All heater screens must be kept closed when operating gas logs.
22. WARNING: Failure to keep primary air opening (s) of the burner (s) clean may result in soot and property damage.
23. Do not use this heater for burning trash or cooking. Never place matches, paper, garbage or any other material on top of logs or into the flames.
24. Do not install or operate this heater in areas where impurities in air exist (such as tobacco smoke or heavy cooking grease). Particles from impurities may discolor walls.
25. Due to high temperatures, appliance should be located out of traffic and away from furniture and draperies.
26. Children and adults should be alerted to hazards of high surface temperature and should stay away to avoid burns or clothing ignition.
27. Young children should be carefully supervised when they are in same room with appliance.
28. An unvented room heater having an input rating of more than 10,000 Btu per hour shall not be installed in a bedroom or bathroom.
29. The appliance and its appliance main gas valve must be disconnected from gas supply piping system during any pressure testing of that system at test pressure in excess of 1/2 psi (3.5 kPa).
30. The appliance must be isolated from gas supply piping system by closing its equipment shut-off valve during any pressure testing of gas supply piping system at test pressures equal to or less than 1/2 psi (3.5 kPa).
31. WARNING: Do not allow fans to blow directly into fireplace. Avoid any drafts that alter burner flame patterns.
32. WARNING: Do not use a blower insert, heat exchanger insert or other accessory not approved for use with this heater.
33. A fireplace screen must be in place when appliance is operating and unless other provisions for combustion air are provided, screen shall have an opening(s) for introduction of combustion air.

SECTION II

FIREPLACE PREPARATION

The fireplace needs to be prepared before installing heater.

- A. Turn off the gas supply to fireplace.

WARNING: BEFORE INSTALLING IN A SOLID-FUEL BURNING FIREPLACE, CHIMNEY FLUE AND FIREBOX MUST BE CLEANED OF SOOT, CREOSOTE, ASHES AND LOOSE PAINT BY A QUALIFIED CHIMNEY CLEANER.

WARNING: DO NOT ALLOW FANS TO BLOW DIRECTLY INTO FIREPLACE. AVOID DRAFTS THAT ALTER BURNER FLAME PATTERNS.

WARNING: DO NOT USE A BLOWER INSERT, HEAT EXCHANGER INSERT OR OTHER ACCESSORIES NOT APPROVED FOR USE WITH THIS HEATER.

WARNING: ANY OUTSIDE AIR DUCTS AND/OR ASH DUMPS IN FIREPLACE SHALL BE PERMANENTLY CLOSED AT TIME OF APPLIANCE INSTALLATION.

- B. Read the following sections before installing your unit; Section III, page 20 “Installation In A Solid-Fuel Burning Fireplace” and Section VIII, page 31 “Producing Adequate Air For Combustion And Ventilation”.

WARNING: CUTTING ANY SHEET-METAL PARTS OF SOLID-FUEL BURNING FIREPLACE OR LISTED VENTLESS FIREBOX ENCLOSURE IN WHICH UNVENTED FIREPLACE INSERT IS TO BE INSTALLED IS PROHIBITED.

NOTE: IF FACTORY BUILT FIREPLACE HAS NO GAS ACCESS HOLE (S) PROVIDED, AN ACCESS HOLE OF 1.5 inch (37.5mm) DIAMETER OR LESS MAY BE DRILLED THROUGH LOWER SIDES OR BOTTOM OF FIREBOX. THIS ACCESS HOLE MUST BE PLUGGED WITH NON-COMBUSTIBLE INSULATION AFTER GAS SUPPLY LINE HAS BEEN INSTALLED. REFRACTORY, GLASS DOORS, SCREEN RAILS, SCREEN MESH AND SOLID-FUEL LOG GRATES (IF APPLICABLE) CAN BE REMOVED FROM FIREPLACE BEFORE INSTALLING UNVENTED FIREPLACE INSERT.

INSTALLATION AND CLEARANCES

To ensure a safe installation into a masonry or factory built fireplace, following instructions must be carefully followed:

- (1) Sidewall Clearances:
Clearance from side of fireplace opening to any adjacent combustible wall should not be less than: right side 7", left side 7".
- (2) Ceiling Clearances:
The ceiling height should not be less than 26" from top of fireplace opening.
- (3) Mantel Clearances:
Clearances from top of heater to mantel or mantel supports should not be less than 20".

NOTE: See following sections for installation options: Section III, page 20, *Installation In A Solid-Fuel Burning Fireplace* and Section IV, page 22, *Installation With Optional Wooden Mantel* and Section V, page 24, *Zero Clearance Installation*.

WARNING: ANY CHANGE TO THIS HEATER OR ITS CONTROLS CAN BE DANGEROUS.

GAS CONNECTION

Check gas type. Use only type of gas indicated on valve rating plate. If type of gas listed on plate is not your type of gas supply, **DO NOT INSTALL**. Contact your dealer for proper model. Always use an external regulator for all LP heaters to reduce supply tank pressure to a maximum of 13" W.C. This is in addition to regulator furnished with heater.

WARNING: CONNECTION DIRECTLY TO AN UNREGULATED LP TANK CAN CAUSE AN EXPLOSION.

Normal gas connection is 3/8" N.P.T. made at left back side of appliance (facing front of appliance).

NOTE: The connecting pipe must be internally tinned copper tubing for use with natural gas. Test for leaks using a solution of soap and water after completing the connection. **DO NOT USE OPEN FLAME**

NOTE: If the factory-built fireplace has no gas access hole provided, an access hole of 1.5 inch (37.5mm) diameter or less may be drilled through lower sides or bottom of fire box. This access hole must be plugged with non-combustible insulation after gas supply line has been installed.

WARNING: Installation and repairs should be performed by a qualified service person. Appliance should be inspected before use and at least annually by a professional service person. More frequent cleaning may be required due to excessive lint from carpeting, bedding material, etc. It is imperative that control compartments, burners and circulating air passageways of appliance be kept clean.

Weathered Wood Log Set Place for Model 34 Manhattan

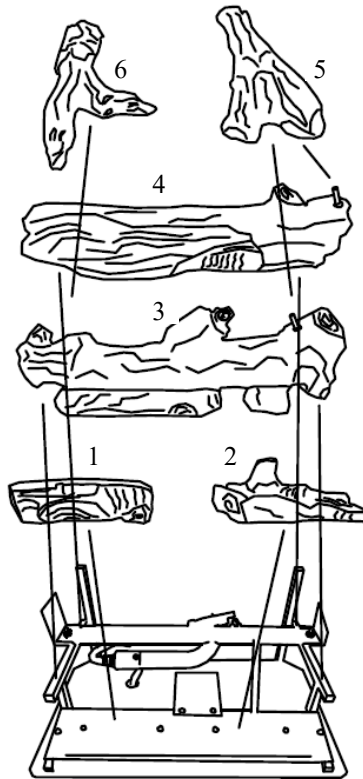

WARNING: Failure to position parts in accordance with these diagrams or failure to use only parts specifically approved with this heater may result in property damage or personal injury.

WARNING: POSITIONING OF LOGS IS VERY CRITICAL (SEE DIAGRAM ABOVE).

MODEL ASPEN: (1)Front Left Log, (2) Front Right Log, (3) Front Main Log, (4) Rear Main Log, (5) Left Crossover Log, (6) Right Crossover Log

- 1) Locate the Front Left and Right logs on the screws attached to the burner base
- 2) Attach the Front Main Log by locating it on the rail, placed in the cut notches on the log
- 3) Attach the Rear Main Log behind the Front Main Log using the notches and rails on the burner
- 4) Attach the Left and Right Crossover Logs using the alignment pins and holes located on the bottoms of the logs.

NOTE: Wash your hands immediately after coming in contact with wool material. The wool can cause slight itching or burning, avoid any contact with eyes.

WARNING: All previously applied loose material must be removed prior to replacement.

E.S.B. LOG SET PLACEMENT FOR MODEL 384

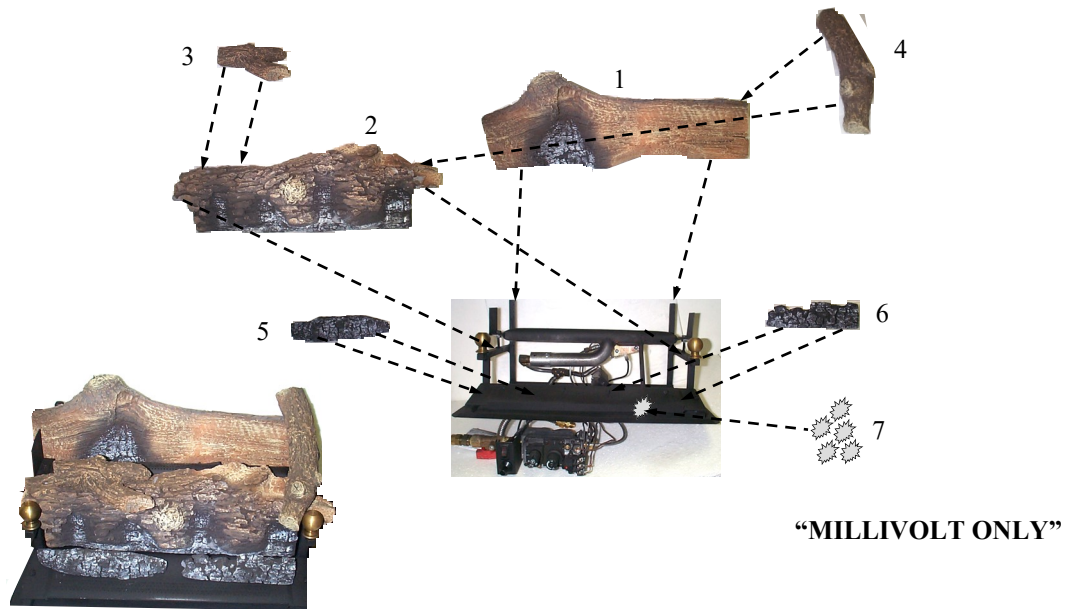

WARNING: Failure to position parts in accordance with these diagrams or failure to use only parts specifically approved with this heater may result in property damage or personal injury.

WARNING: POSITIONING OF LOGS IS VERY CRITICAL (SEE DIAGRAM ABOVE).

MODEL E.S.B: (1) Rear Log, (2) Middle Log, (3) Left Top Middle Log, (4) Right Top Middle Log (5), Left Front Log (6), Right Front Log (7), Glowing Embers in front of 5 & 6 logs.

WARNING: POSITIONING OF LOGS IS VERY CRITICAL (See Figure 2).

- 1) Place rear log #1 on rear log supports. The log has alignment notches on each back corner.
- 2) Place Middle log #2 in front of rear burner tube and then move log forward. The log should sit just behind brass knob (s), located in middle section of base between back burner tube and front burner pan.
- 3) Place Left Top Middle log #3 on pins located on left top section of Middle log #2.
- 4) Place Right Top Middle log #4 on pin located on right top section of Middle log #2 and align notch on right side #4 with side shield on right.
- 5) Place Left Front log #5 on locator pins located on left middle section of front burner pan.
- 6) Place Right Front log #6 on locator pins located on right middle section of front burner pan.
- 7) Provided with your log set is a package of Glowing Embers (rock wool). Open package and tear off small pieces of wool material and place it over small holes (ports) located on front burner pan in front of logs #5 and #6. Cover entire section of holes (ports).

***Replacement of loose (Glowing Embers) must be purchased from the original manufacturer and application of excess loose material may adversely affect performance of heater.**

NOTE: Wash your hands immediately after coming in contact with wool material. The wool can cause slight itching, avoid any contact with eyes.

WARNING: All previously applied loose material must be removed prior to replacement.

Temperature and timer se

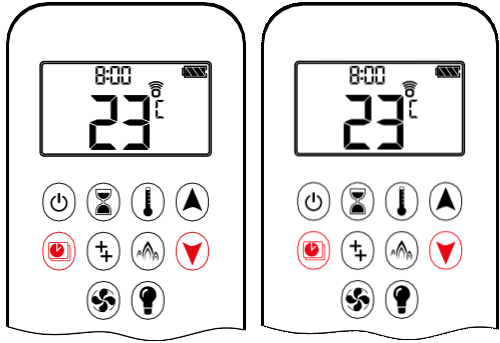

FUNCTION ACTIVATION/DEACTIVATION

Deactivate Functions

1. Install batteries. All icons are displayed and flashing.
2. While the icons are flashing, press the relevant function button and hold for 10 sec.
3. The function icon will flash until deactivation is complete. De-activation is complete when the function icon and two horizontal bars “--” are displayed.

NOTE: If a deactivated button is pressed, there is no function, and two horizontal bars “--” are displayed.

NOTE: Deactivation remains in effect after change of batteries.

Activate Functions

1. Install batteries. All icons are displayed and flashing.
2. To activate a function, press the relevant button and hold for 10 sec.
3. The function icon will continue to flash until activation is complete. Activation is complete when the function icon is displayed.

The following Functions can be Deactivated/Activated

- CHILD PROOF
- PROGRAM MODE
- THERMOSTATIC MODE (also deactivates PROGRAM MODE)
- ECO MODE
- LIGHT/DIMMER OPERATION
- CIRCULATING FAN OPERATION
- 2ND BURNER FUNCTION
- COUNTDOWN TIMER

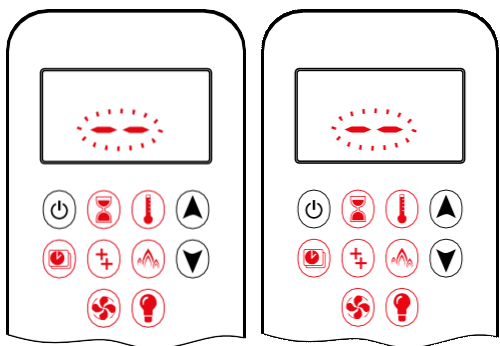

GENERAL NOTES

Batteries – Handset

Low battery indicator on Symax.

Handset One Button and Two Button Ignition

Change from one button (default setting) to two button ignition or vice versa by

pressing and holding  button for 10 sec. immediately after installing batteries. **ON** is displayed and **1** or **2** (One or Two Button Ignition) is flashing. When change is complete **1** changes to **2** or vice versa.

8 AND 10-BUTTON HANDSET OPERATION

SETTING FAHRENHEIT OR CELSIUS

CHILD PROOF

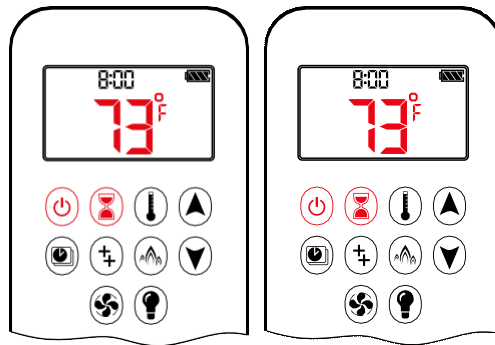





To change between °C and °F, press

 and  buttons simultaneously.

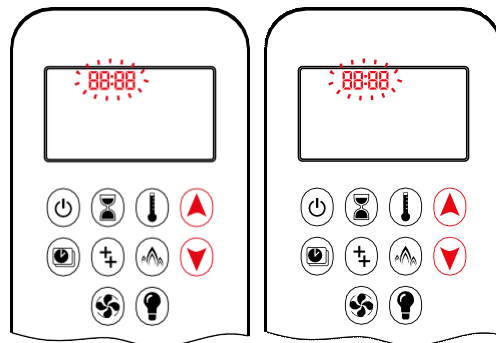
NOTE: Choosing °F results in a 12 hour clock. Choosing °C results in a 24 hour clock.

SETTING THE TIME



1. Press  and  buttons simultaneously. **Day** flashes.
2. Press  or  button to select a num-

▼ ▼ ber to correspond with the day of the week (e. g. 1 = Monday, 2 = Tuesday, 3 = Wednesday, 4 = Thursday, 5 = Fri- day, 6 = Saturday, = Sunday).

3. Press ▲ and buttons simultane- ously. **Hour** flashes.
4. To select hour press ▲ or ▼ button.
5. Press ▲ and ▼ buttons simultane- ously. **Minutes** flash.
6. To select minutes press ▲ or button.
7. To confirm press ▲ and buttons simultaneously or wait.

ON:

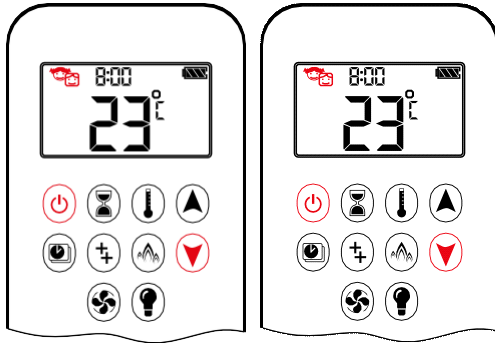

- To activate press ⏻ and ▼ buttons simultaneously.
- 👁️ is displayed and the Symax is rendered inoperable, except for the **OFF** function.

OFF:

- To deactivate press ⏻ and ▼ buttons simultaneously.
- 👁️ 👁️ disappears.

MANUAL MODE (HANDSET)

TO TURN ON FIRE

WARNI NG ▲ WARNI NG ▲

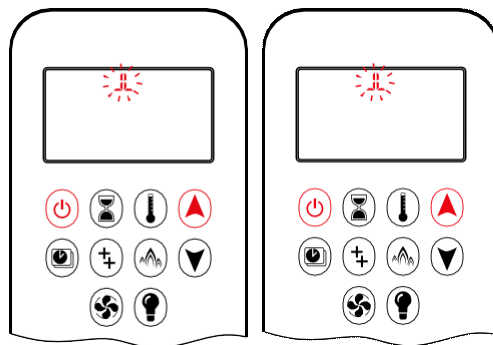

- Press ⏻ button (One Button Ignition) or ⏻ and ▲ button simultaneously (Two Button Ignition) until two short beeps (CE, AGA version) or continu- ous beeping (CSA version) and a blinking series of lines con- firms the start sequence has begun; release button(s).
- Main gas flows once pilot ignition is confirmed.
- The Symax automatically goes into Manual Mode after main burner ignition.

FLAME HEIGHT ADJUSTMENT

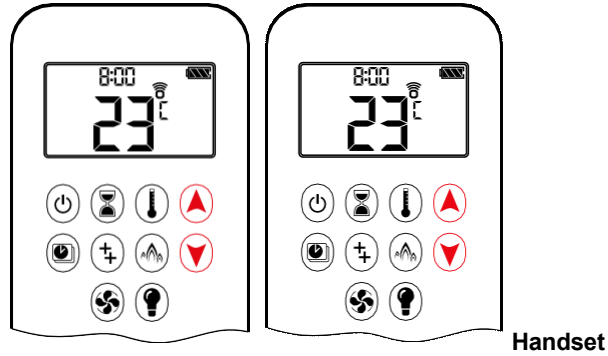

- To increase flame height press and hold ▲ button.
- To decrease flame height or to set appliance to pilot flame, press and hold ▼ button.

DESIGNATED LOW FIRE AND HIGH FIRE

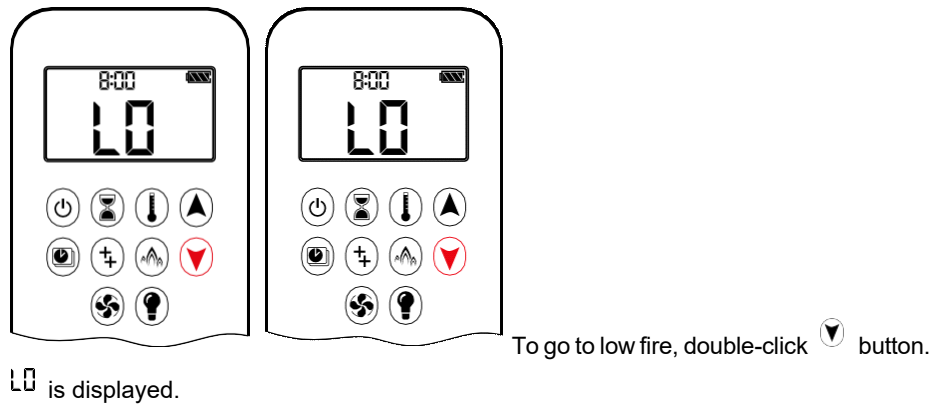

- LO is displayed.

NOTE: Flame goes to high fire first before going to low fire.

WARNING ▲ WARNING ▲ STANDBY MODE (PILOT FLAME)

Handset

- Press and hold ▼ button to set appliance to pilot flame.

TO TURN OFF FIRE

- Press ⏻ button to turn off. (the handset must be in **ON** mode).

NOTE: A new ignition is possible after the **OFF** icon stops flashing.

SYSTEM OVERRIDE SHUTOFF

Handset

- If the fire will not Shutoff by pressing the ⏻ button, press and hold the ⏻ button for 12 seconds to shut the fire off.
- To go to high fire, double-click ▲ button.

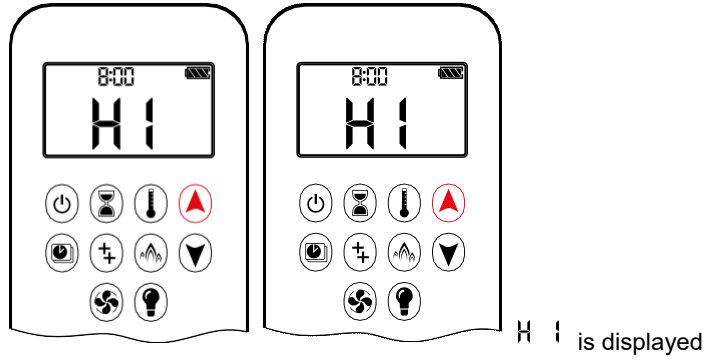

WARNING ▲ WARNING ▲
COUNTDOWN TIMER

ON/SETTING:

1. Press and hold button until is displayed, and **hour** flashes.
2. To select hour press or button.
3. To confirm press button. **Minutes** flash.
4. To select minutes press or button.
5. To confirm press button or wait.

OFF:

- Press button.
- and Countdown Time disappear.

NOTE: At end of Countdown Time period, the fire shuts off. The Countdown Timer only works in Manual, Thermostatic, and Eco Modes. Maximum Countdown Time is 9 hours and 50 minutes.

MODES OF OPERATION

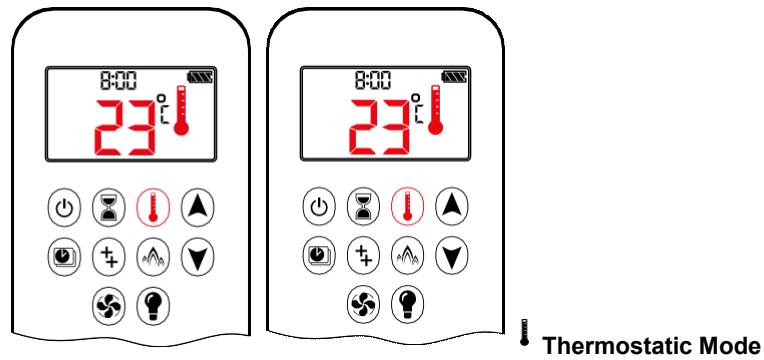

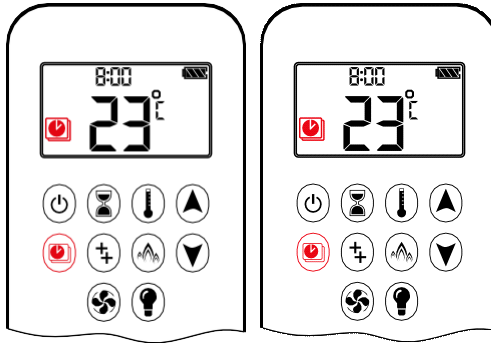

The room temperature is measured and compared to the set temperature. The flame height is then automatically adjusted to achieve the set temperature.

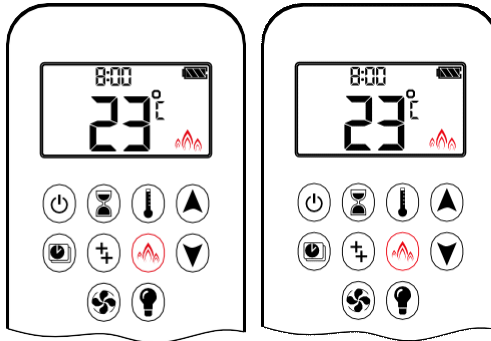

 **Program Mode**

PROGRAM 1 and 2, each can be programmed to go ON and OFF at specific times at a set temperature.





 **Eco Mode**

Flame height modulates between high and low. If the room temperature is lower than the set temperature, the flame height stays on high for a longer period of time. If the room temperature is higher than the set temperature, the flame height stays on low for a longer period of time. One cycle lasts approx. 20 min.

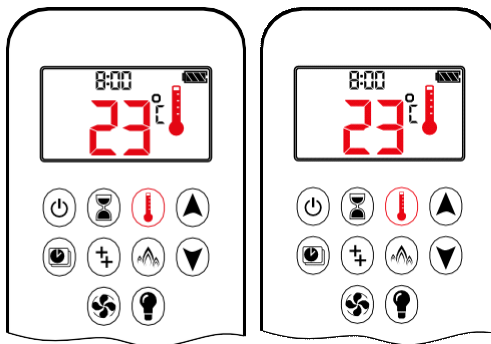



THERMOSTATIC MODE



ON:

- Press  button.
-  is displayed, preset temperature is displayed briefly, and then room temperature is displayed.

OFF:

1. Press  button.
2. Press  or  button to enter Manual Mode.
3. Press  button to enter Program Mode.
4. Press  button to enter Eco Mode.

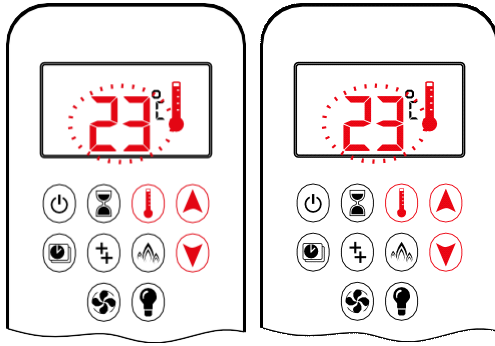

SETTING:

1. Press button and hold until is displayed, temperature flashes.
2. To adjust set temperature press or button.
3. To confirm press button or wait.

PROGRAM MODE

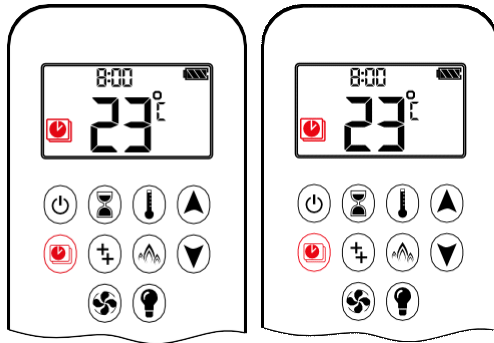

4. The setting process can be canceled at any time by pressing the button. However, settings made so far will be saved.

2 2 ON:

- Press button.
- , **1** or **ON** or **OFF** is displayed.

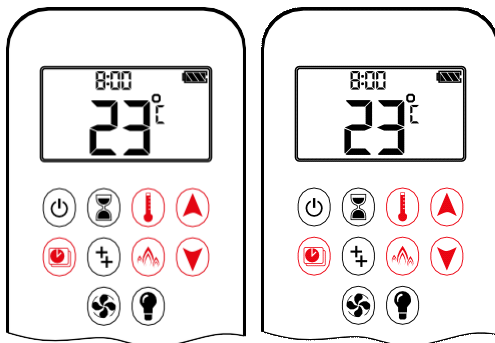

OFF:

1. Press button.
2. Press or button to enter Manual Mode.
3. Press button to enter Thermostatic Mode.
4. Press button to enter Eco Mode.

NOTE: The set temperature for Thermostatic Mode is the temperature for the **ON** time in Program Mode.

Changing the Thermostatic Mode set temperature also changes the **ON** time temperature in Program Mode.

Default settings:

ON TIME (Thermostatic) TEMPERATURE: 70°F/21°C

OFF TIME TEMPERATURE: “ -- ” 41°F/5°C (pilot flame only)

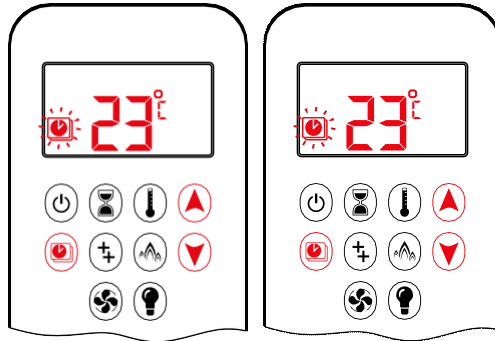

ON ON TEMPERATURE SETTING:

SETTING:

1. OFF OFF Press button and hold until flashes, and set temperature (setting in Thermostatic Mode) is displayed.
2. To continue press button or wait for 8 seconds. , is displayed, temperature flashes.
3. Select OFF temperature by pressing the ▲ or ▼ button.
4. To confirm press button.

NOTE: The ON (Thermostatic) and OFF set temperatures are the same for each day.

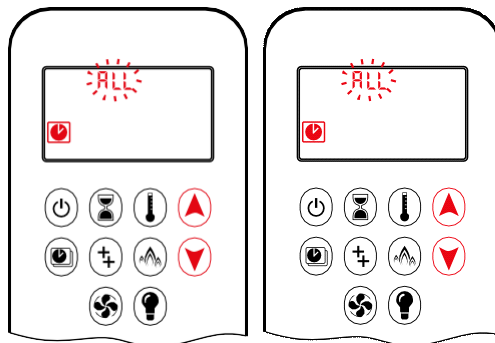

▲ LL ▲ LL ▼ 5A-5U ▼ 5A-5U DAY

SETTING:

5. ALL flashes. Press or button to choose between , , 1, 2, 3, 4, 5, 6, 7.
6. To confirm press button.selected

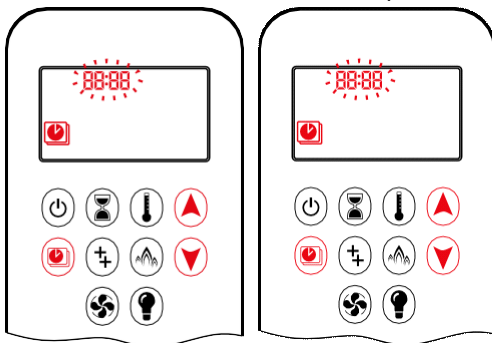

ON TIME SETTING (PROGRAM 1):

7. , **1**, **ON** is displayed, **ALL** is displayed shortly, and **hour** flashes.
8. To select hour press or button.
9. To confirm press button. **1**, **ON** is displayed, is displayed shortly, and **minutes** flash.
10. To select minutes press or button.
11. To confirm press button.

ON:

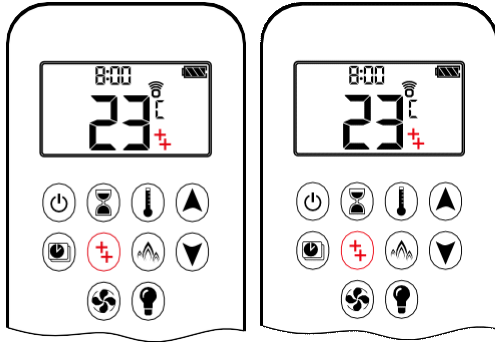

- To switch a burner **ON**, press the button.
 - displayed.
- OFF:**
- To switch the burner **OFF**, press the button.
 - disappears.

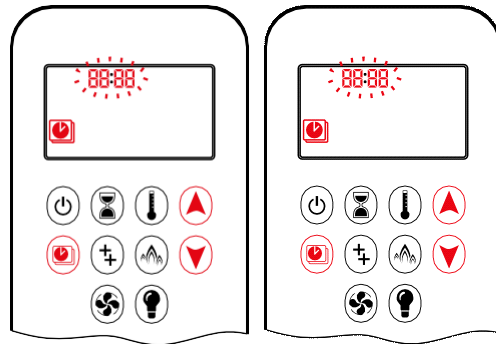

OFF TIME SETTING (PROGRAM 1):

12. , **1**, **OFF** is displayed, **ALL** is displayed shortly, and **hour** flashes.
13. To select hour, press or button.
14. To confirm press button. , **1**, **OFF** is displayed, is displayed shortly, and **minutes** flash.
15. To select minutes press or button.
16. To confirm press button.

NOTE: Either continue to PROGRAM 2 and set **ON** and **OFF** times or stop programming at this point, and PROGRAM 2 remains deactivated.

NOTE: PROGRAM 1 and 2 use the same **ON** (Thermostatic) and **OFF** temperatures for **ALL**, **SARSU** and Daily Timer (, , , , , , , , , , ,). Once a new **ON** (Thermostatic) and / or **OFF** temperature has been set, that temperature becomes the new default setting.

NOTE: If **ALL**, **SARSU** or Daily Timer are programmed for PROGRAM 1 and PROGRAM 2 **ON** and **OFF** times, these become the new default times. The batteries must be removed to clear the PROGRAM 1 and

PROGRAM 2 **ON** and **OFF** times and temperatures.



SAR:SU or Daily Timer (1 , 2 , 3 , 4 , 5 , 6 , 7) selected

- Set **ON** time and **OFF** time using same procedure as “ **ALL selected**” (above).
- SAR:SU : Set **ON** time and **OFF** time for both Saturday and Sunday.
- Daily Timer: Unique **ON** and **OFF** times may be set for a single day of the week, for multiple days of the week, or for every day of the week.
- Wait for 8 seconds or press the  button to finish setting.





NOTE: The latching solenoid valve cannot operate manually. If the receiver battery runs down it will remain in the last operating position.

ECO MODE

ON:

- Press  button to enter Eco Mode.
-  is displayed.

OFF:

1. Press  button.
2. Press  or  button to enter Manual Mode.
3. Press  button to enter Thermostatic Mode.
4. Press  button to enter Program Mode.

MYFIRE APP

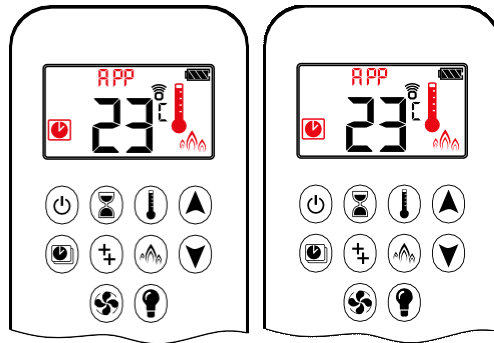

If Thermostatic, Program or Eco Mode is activated in the App, the corresponding icon and “ **APP** ” is displayed on the handset.

The modes can be operated according to the descriptions on previous pages.

NOTE: In Manual Mode “ **APP** ” is NOT displayed on the handset.

2ND BURNER FUNCTION

The latching solenoid valve will open automatically after ignition or after switching the system **OFF**, so that the maximum flow of gas is supplied to both burners assisting with the ignition process. After pressing the button for the 2nd Burner the motor will turn 15 seconds in the **ON** direction until the max. position is reached.

A latching solenoid with reverse polarity and reverse operation is available as an option. Contact Maxitrol for more information.

10-BUTTON HANDSET OPERATION ONLY



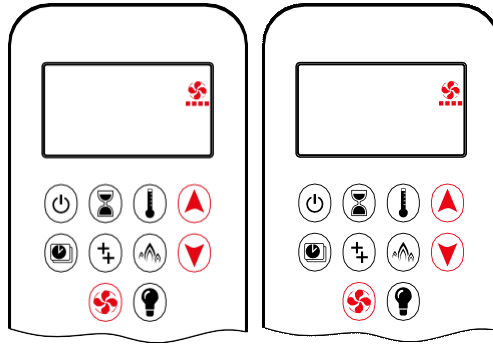



CIRCULATING FAN OPERATION



low (1 bar) to high (4 bars).

Circulating fan has 4 speed levels from







ON/SETTING:

1. Press  button and hold until  flashes.
2. Press  button to increase fan speed and  button to decrease fan speed.
3. To confirm setting either press  button or wait ( displayed).

OFF:

- Press  button until all 4 speed level bars disappear.

NOTE: SETTING only. If the fan was not switched **OFF** after last use, it starts automatically 4 minutes after ignition at maximum speed and goes to the last set level after 10 seconds. The fan stops 10 minutes after the gas is **OFF** or at pilot.

1. Press  button and hold until  flashes.
2. Press  button to increase fan speed and  button to decrease fan speed.
3. To confirm setting either press  button or wait ( displayed).

OFF:



- Press  button until all 4 speed level bars disappear.

NOTE: SETTING only. If the fan was not switched **OFF** after last use, it starts automatically 4 minutes after ignition at maximum speed and goes to the last set level after 10 seconds. The fan stops 10 minutes after the gas is **OFF** or at pilot.

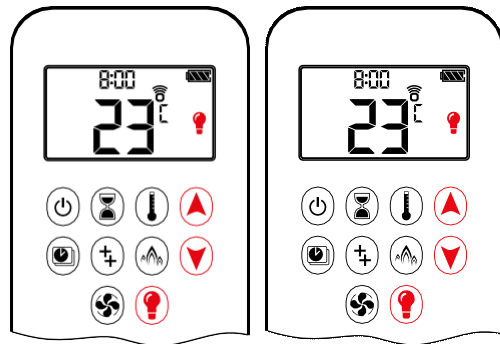

LIGHT/DIMMER OPERATION



ON:

- Press  button ( is displayed).
- Light is **ON** at preset level.

OFF:

- Press  button ( disappears).

GAS PRESSURE CHECK

Check inlet pressure to burner to ensure that it is as shown in table below. **NOTE:**The pressure check point is located on the right side of valve facing burner, for SIT Millivolt, and left side for SIT Modulating.

Appliance and its appliance main gas valve must be disconnected from the gas supply piping system during any pressure testing of that system at test pressures in excess of 1/2 psi (3.5kPa). Appliance must be isolated from gas supply piping system by closing its equipment shut-off valve during any pressure testing of gas supply piping system at test pressures equal to or less than 1/2 psi (3.5 kPa).

VALVE MODEL:	(MILLIVOLT)		(SIT MANUAL-MODULATING)	
	FP384	FP384	FP384	FP384
<u>GAS TYPE</u>	<u>Natural</u>	<u>Propane</u>	<u>Natural</u>	<u>Propane</u>
Maximum Heat Input	33,000	33,000	33,000	33,000
Minimum Heat Input	23,000	23,000	12,000	13,000
<u>Gas Inlet Pressure</u>				
Maximum	10.5ins.W.C.	13ins.W.C.	10.5ins.W.C.	9.0ins.W.C.
Minimum	*5.0ins.W.C.	*11ins.W.C.	*5.0ins.W.C.	*11ins.W.C.
<u>Manifold Pressure</u>				
Maximum	3.5ins.W.C.	9.0ins.W.C.	3.5ins.W.C.	9.0ins.W.C.
Minimum	3.0ins.W.C.	8.2ins.W.C.	2.8ins.W.C.	7.2ins.W.C.

NOTE: On initial installation it may be necessary to bleed out air in the gas lines. Do this by holding the control knob and turning the knob to the “PILOT” position for about 30 seconds. To check the regulator pressure, remove the pressure tag plug at the left side of the regulator facing the heater. The pressure should be checked with the heater burning and the control set on high. After measuring the pressure, replace the pressure tag plug, ensuring that there are no leaks.

- For the purpose of minimum input adjustment.

WARNING

This appliance is equipped for (natural or propane) gas. Field conversion is not permitted.

Solid fuels shall not be burned in the same fireplace where an unvented room heater has been installed.

NOTE: The following label has been provided with this appliance and must be read and then attached to floor of the fireplace or firebox area beneath the appliance. The label is a peel and stick label. Make sure the area is cleaned before attaching label to it.

WARNING: This solid-fuel burning fireplace or listed vent less enclosure has been converted for use with an unvented fireplace insert only. A solid-fuel burning fireplace cannot be used for burning wood or solid fuels unless all original parts have been replaced and fireplace re-approved by the authority having jurisdiction. A vent less firebox enclosure cannot be used with an unvented gas log unless all original parts have been replaced and vent less firebox enclosure re-approved by authority having jurisdiction.

OPERATING INSTRUCTIONS

Before operating this appliance, proceed through following checklist.

1. Read and understand these instructions before operating this appliance.
2. Check that there are no gas leaks. If you smell gas do not attempt to light this appliance.
3. Verify that log placement is correct.

WARNING: ANY CHANGE TO THIS HEATER OR ITS CONTROLS CAN BE DANGEROUS.

LIGHTING INSTRUCTIONS

SIT-MILLIVOLT VALVE FOR YOUR SAFETY READ BEFORE LIGHTING

WARNING: If you do not follow these instructions exactly, a fire or explosion may result causing property damage, personal injury or loss of life.

- A. This appliance has a pilot which must be lit by hand. When lighting pilot follow these instructions exactly. If piezo fails, then light pilot using matches. Refer to match lighting instructions.
- B. **BEFORE LIGHTING** smell all around appliance area for gas. Be sure to smell next to floor because some gas is heavier than air and will settle to floor.

WHAT TO DO IF YOU SMELL GAS:

- * Do not try to light any appliance.
 - * Do not touch any electric switch; do not use any phone in your building.
 - * Immediately call your gas supplier from a neighbor's phone. Follow gas supplier's instructions.
 - * If you cannot reach your gas supplier, call fire department.
- C. Use only your hand to push in or turn gas knob. Never use tools. If knob will not push in or turn by hand, don't try to repair it. Call a qualified service technician. Forced or attempted repairs may result in a fire or explosion.
 - D. Do not use this appliance if any or part of it has been under water. Immediately call a qualified service technician to inspect the appliance and to replace any part of the control system and any gas control which has been under water.

LIGHTING INSTRUCTIONS

1. **STOP!** Read the safety information on reverse side of this label (page 8).
2. Make sure manual shutoff valve is fully closed. If equipped with thermostat, set to lowest setting.
3. Turn off all electrical power to appliance.
4. Open access door located at bottom of front of appliance.
5. Push in gas control knob slightly and turn clockwise  to full "OFF" position.

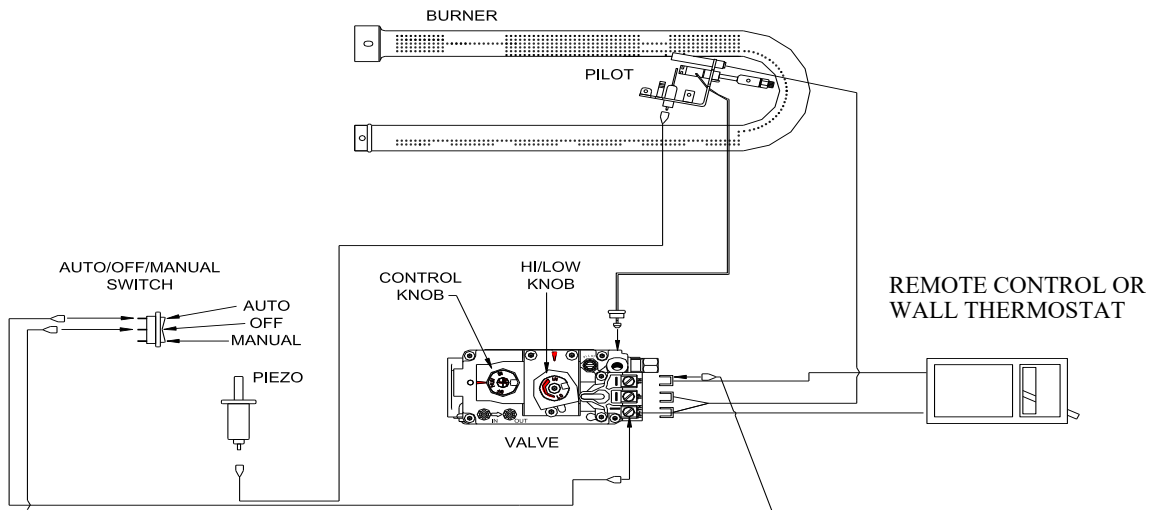

NOTE: Knob cannot be turned from "PILOT" to "OFF" unless knob is pushed in slightly. Do not force.

6. Wait (5) five minutes to clear out any gas. Then smell for gas, including near the floor. If you smell gas, **STOP!** Follow "B" in the safety information on the previous page. If you don't smell gas, go to the next step.
7. Find Pilot: The pilot is located in front of rear log and burner on right hand side of appliance. Fully open manual shutoff valve.
8. Press in and turn knob on gas control counterclockwise  to "PILOT" and continue pressing in knob for (15) fifteen seconds.
9. With control knob pressed in push down (in) and release igniter button (igniter button is located on front left hand side of appliance). This will light pilot. If needed, keep repeating this step until pilot lights.
10. Keep control knob pressed in for (1) one minute after lighting pilot. After (1) minute, release control knob and it will pop back up. Pilot should remain lit. If pilot goes out, repeat steps 1 through 9.
 - If knob does not pop up when released, stop and immediately call your service technician or gas supplier.
 - If pilot will not stay lit after several tries, turn the gas control knob to "OFF" and call your services technician or gas supplier.

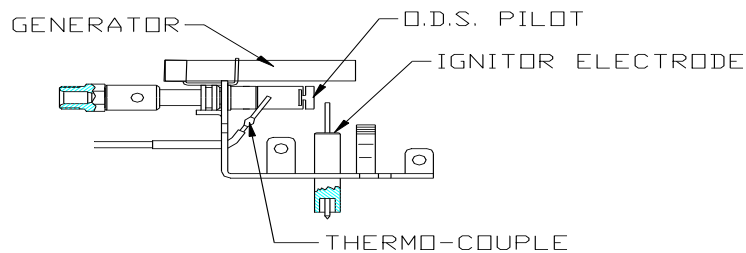

11. Turn control knob counterclockwise  to "ON".
12. If using unit without wall thermostat place Auto/Off/Manual switch to manual position. If using wall thermostat place Auto/Off/Manual switch to auto position and place thermostat to a setting higher than room temperature.
13. Close access cover door.
14. Turn on all electrical power to appliance.
15. Your heater is equipped with a HI & LO control. Turn clockwise for Low and counterclockwise for High.

CAUTION

DO NOT TRY TO ADJUST HEATING LEVELS BY USING MANUAL SHUTOFF VALVE.

TO TURN OFF GAS TO APPLIANCE

SHUTTING OFF UNIT

1. Open access cover door.
2. If equipped with thermostat set to lowest setting.
3. Turn control knob clockwise  to full "OFF".
4. Turn off all electric power to appliance if service is to be performed.
5. Close access cover door.

SHUTTING OFF BURNER ONLY (Pilot stays lit.)

Turn control knob clockwise  to "PILOT" position.



CAUTION: Hot while in operation. Do Not Touch. Keep children, clothing, furniture, gasoline and other liquids having flammable vapors away.

CAUTION: DO NOT TRY TO ADJUST HEATING LEVELS BY USING MANUAL SHUTOFF VALVE.

WARNING: Improper installation, adjustment, alteration, service or maintenance can cause property damage, personal injury or loss of life. Refer to owner's information manual provided with this appliance. Installation and service must be performed by a qualified installer, service agency or gas supplier.

IMPORTANT: Always operate appliance at completely "ON" or completely "OFF" positions. Never use heater at a setting between these positions as this can result in improper combustion and excessive carbon monoxide emissions.

MANUAL LIGHTING PROCEDURE

1. If pilot cannot be lit with piezo, it can be manually lit with the use of a paper match and a lighter rod.
2. Open access panel door located at bottom front of appliance.
3. Place match in holder and light. With left hand, turn control knob counterclockwise to "PILOT" position. Press in gas control knob for fifteen (15) seconds. 
4. Use rod to light match and ignite pilot. Pilot is located in front of rear log and burner on right hand side of appliance.
5. Continue to hold the control knob for an additional one (1) minute to ensure pilot is lit.
6. Turn control knob counterclockwise  to "ON" position. Push "ON/ OFF" toggle switch to "ON" position. Main burner should light.
7. Close access panel door.
8. Turn on all electrical power to appliance.

NOTE: This unit may be used with an optional Wall Thermostat. If so, Wall Thermostat needs to be set at a higher temperature than the room temperature.

FLAME CHECK

A periodic check of the flames should be made. The pilot flame should always be present when gas logs are in operation. See Figure 4.

Rear Flames: The flames at back or at either side of top log should be very similar, yellow in color, and should be about 3" to 4" above large rear log for natural gas logs and about 6" for propane (LP) gas log sets.

Front Flame: The flame should be 1-1/2" to 2" high and touch the back of front log. This will produce a red glow on this log.

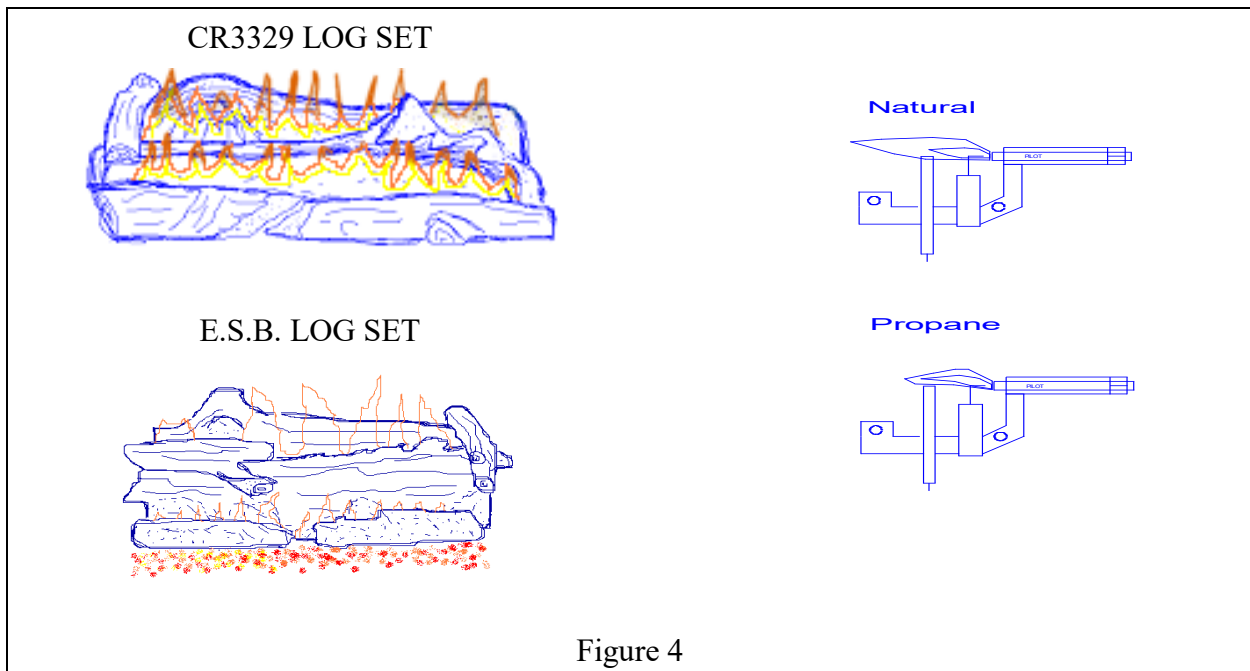

Figure 4

WHEN USED AS A HEATING APPLIANCE HEAT OUTPUT

When used as a ventless heater, flue damper of a solid-fuel burning non-combustible fireplace must always be closed.

The heat output is controlled by the "ON/OFF" switch or wall thermostat, when using Millivolt Valve. When using SIT Modulating or SIT Manual Valve, heat output is controlled by dial with LOW to HIGH settings. The Vent-Free fireplace may be installed where permitted by local, state and city codes.

In the absence of local codes, the latest edition of the *National Fuel Gas Code (ANSI Z223.1)* must be met.

WIRING DIAGRAM

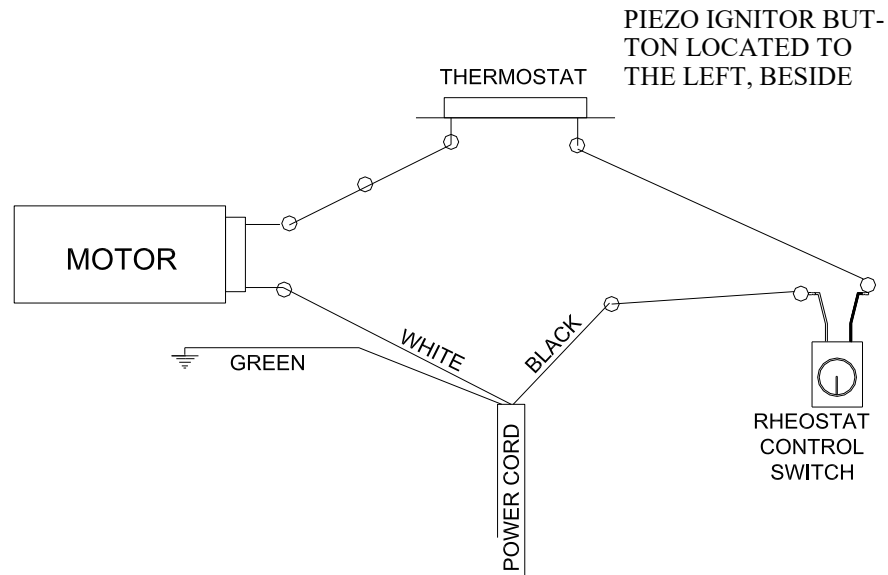

Figure 5

WARNING: CHILDREN AND ADULTS SHOULD BE ALERTED TO HAZARDS OF HIGH SURFACE TEMPERATURES AND SHOULD STAY AWAY TO AVOID BURNS OR CLOTHING IGNITION. YOUNG CHILDREN SHOULD BE CAREFULLY SUPERVISED WHEN THEY ARE IN SAME ROOM WITH APPLIANCE

WARNING: DO NOT PLACE CLOTHING OR OTHER FLAMMABLE MATERIAL ON OR NEAR APPLIANCE.

NOTE: If any of the original wire as supplied with the gas appliance must be replaced, it must be replaced with a wire of at least a 105° C. temperature rating.

NOTE: Installation and repair should be done by a qualified service person. This heater should be inspected before use and at least annually by a qualified service person. More frequent cleaning may be required due to excessive lint from carpeting, bedding material, etc. It is imperative that control compartments and circulating air passageways of heater be kept clean.

CAUTION: Label all wires prior to disconnection when servicing controls. Wiring errors can cause improper and dangerous operation.

Verify proper operation after servicing.

WARNING: ELECTRICAL GROUNDING INSTRUCTION: HEATER IS EQUIPPED WITH A THREE-PRONG PLUG FOR YOUR PROTECTION AGAINST SHOCK HAZARD AND SHOULD BE PLUGGED DIRECTLY INTO A PROPERLY GROUNDED THREE-PRONG RECEPTACLE.

NOTE: #PE SBRO84 Blower Motor.
Rating: 120 volts/60HZ/1.1 Amps.

NOTE: For convenience, allow licensed electrician to install properly grounded 3-plug receptacle near unit.

SECTION III

INSTALLATION MODEL 384 (FP) IN SOLID FUEL BURNING FIREPLACES

- (1) Model FP-384 may be installed in a masonry fireplace. The **minimum fireplace dimension** must be 24" high, 32-1/2" wide, and 12" deep. **NOTE:** Damper or clean out must be closed or sealed off.
- (2) For minimum dimensions for the sidewall and mantel, see drawing below.
- (3) Center heater in fireplace opening.

NOTE: See "Producing Adequate Air for Combustion And Ventilation" page 26.

NOTE: Installer of this appliance must mechanically (peel and stick) attach marking supplied with this unvented appliance before installing to inside of firebox of solid-fuel burning fireplace or listed vent less firebox enclosure into which unvented fireplace insert is installed. See example of marking on page 8 of this manual.

CAUTION: Cutting any sheet-metal parts of solid-fuel burning fireplace or listed vent less enclosure in which unvented fireplace is to be installed is prohibited.

NOTE: If factory-built fireplace has no gas access hole(s) provided, an access hole of 1.5 inch (37.5) diameter or less may be drilled through lower sides or bottom of firebox. This access hole must be plugged with non-combustible insulation after the gas supply line has been installed."

Refractory, glass doors, screen rails, screen mesh and solid-fuel log grates (if applicable) can be removed from fireplace before installing unvented fireplace insert.

NOTE: After the unit is positioned in fireplace, mark trim panels as follows:

- A. Set side panels in place, flat against fireplace. Mark down inside edge of trim panel to make a vertical reference line.

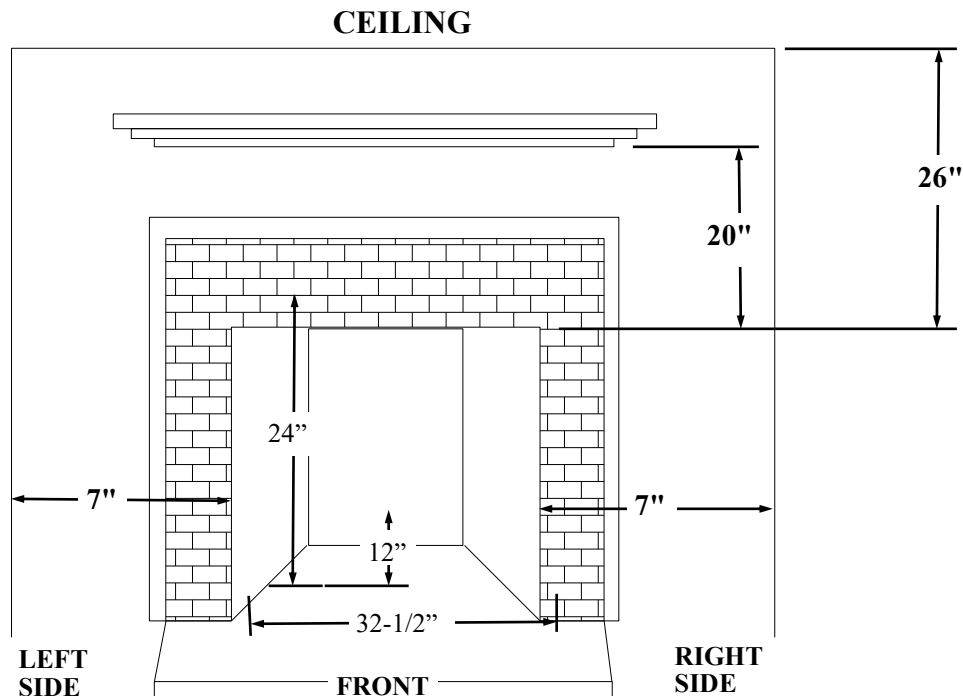

- B. Set top (long) trim panel in place on top of unit. Panel should be flat against outside face of fireplace and standing vertically (measuring approximately 12" from rear of unit to front area). Mark along lower edge of trim panel with a pencil to make reference line for mounting.

NOTE: If used in installation trim panels or surrounds shall not seal ventilation openings in fireplace. **Also provide adequate clearances around air openings.**

- (4) Slide the unit out of fireplace far enough to work behind trim panel reference lines with a screw gun.

NOTE: You need to make sure supply gas line is hooked up at this time. Be sure to check for leaks at connection using soap and water. **DO NOT USE OPEN FLAME TEST FOR LEAKS**

- (5) With screws provided, attach both side trim panels. Next, attach top trim panels.
- (6) Slide heater back into fireplace with trim panels flat against face of fireplace.
- (7) After hooking up gas line, checking for leaks and mounting trim panels slide heater into fireplace.
- (8) Place logs on burner base as shown on page 6.
- (9) For gas hook-up and pressure tap test, see instruction in Section II.

NOTE: Smoke shelves, shields and baffles may be removed if attached by mechanical fasteners.

WARNING: Solid-Fuels shall not be burned in a fireplace in which an unvented room heater is installed.

CAUTION: Any outside air ducts and/or ash dumps in the fireplace shall be permanently closed at time of appliance installation.

WARNING: Before installing in a solid-fuel burning fireplace, the chimney flue and firebox must be cleaned of soot, creosote, ashes and loose paint by a qualified chimney cleaner.

SECTION IV

INSTALLATION OF MODEL 384 (WS) OPTIONAL WOODEN SURROUND (KIT#PAKDM384)

(1) When choosing right location for your heater and surround (mantel) keep the following in mind:

NOTE: Due to high temperatures, this heater should be located out of traffic areas and away from furniture and draperies.

CAUTION: INSTALLATION MUST CONFORM TO LOCAL CODES. IN THE ABSENCE OF LOCAL CODES, INSTALLATION MUST CONFORM WITH NATIONAL GAS CODES.

NOTE: See Section II for gas hookup and pressure check.

NOTE: See "Producing Adequate Air For Combustion And Ventilation" page 26.

WARNING: CHILDREN AND ADULTS SHOULD BE ALERTED TO HAZARDS OF HIGH SURFACE TEMPERATURES AND SHOULD STAY AWAY TO AVOID BURNS OR CLOTHING IGNITION. YOUNG CHILDREN SHOULD BE CAREFULLY SUPERVISED WHEN THEY ARE IN SAME ROOM WITH APPLIANCE

WARNING: DO NOT PLACE CLOTHING OR OTHER FLAMMABLE MATERIAL ON OR NEAR APPLIANCE.

(2) Position screen before leaving heater unattended.

(3) Instructions for assembly of Wooden Surround (Mantel):

TOOLS NEEDED: Medium Phillips screwdriver, tape measure, power drill, and 5/16" socket.

STEP 1: Lay out all components.

STEP 2: Assemble end panels A & B to top front rail C.

STEP 3: Stand end panels and top front rail onto hearth.

NOTE: (Position back of end panels with back of hearth, centering assembly from each end). Install front screws first, then pull back towards inside to square mantel. Install screws through back holes.

STEP 4: The owner must decide at this time if parts D, E, and F are to be wood or green. Beginning with panel E stand chosen color face out on hearth, flush against stop block, located inside end panel A. Attach. Position left end of top window D on top of E and attach. Slide panel F under right end of D and attach.

STEP 5: Place a cloth or blanket over front portions of mantel as not to scar wooden part of mantel.

The Manufacturers Trim Kit must be used for Wooden Surround Installation.

1. Set top (long) trim panel in place on top of unit. The panel should be flat against outside face of fireplace, and standing vertically (measuring approximately 12" from rear of unit to front area). Mark along lower edge of trim panel with a pencil to make reference line for mounting.
2. Set side panels in place, flat against fireplace. Mark down inside edge of trim panel to make a vertical reference line.

STEP 6: Slide unit into front opening of surround so top metal trim panel and outer sides of heater meet flush with the surround front.

STEP 7: Remove cloth or blanket from underneath stove.

STEP 8: Take two metal “ell” brackets with screws provided and anchor back of fireplace to surround (mantel).

STEP 9: Place top on to surround (mantel), flush with back and equal on each end. Secure both ends and middle with screws.

EXPLODED VIEW OF MODEL 384 SURROUND KIT# PAKDM384

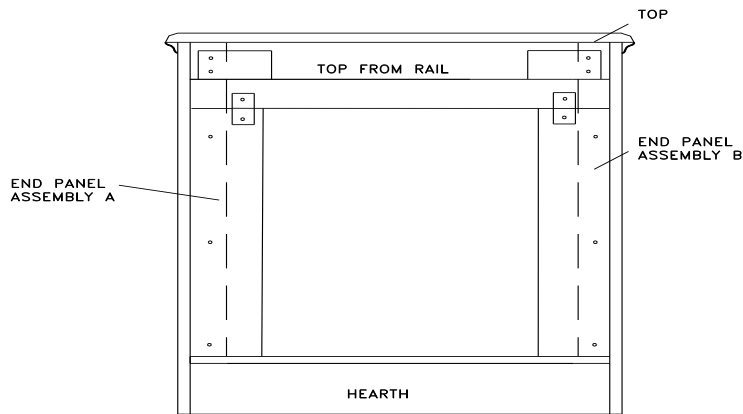
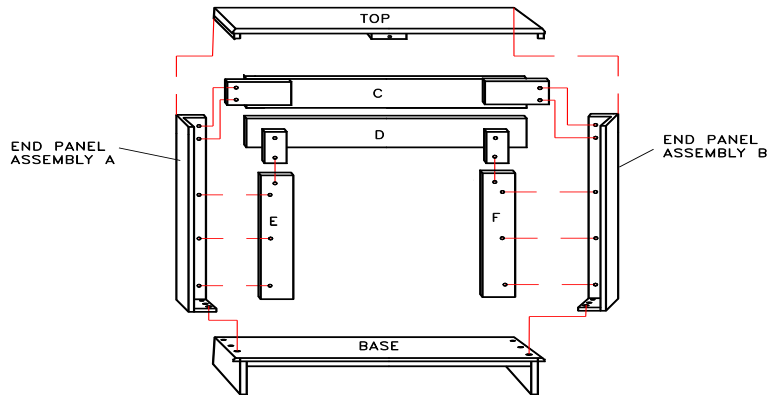

AS VIEWED FROM BACK OF SURROUND (MANTEL)

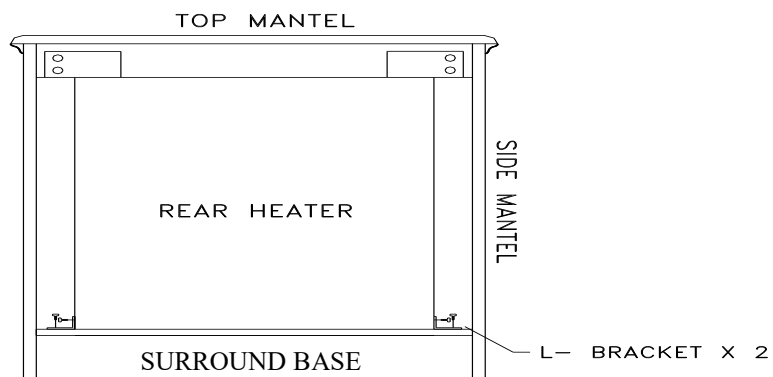

SECTION V

MODEL 384 (ZC) ZERO CLEARANCE INSTALLATION

The installation must conform with local codes or in the absence of local codes, with *National Fuel Gas Code, ANSI Z223.1/NFPA54*.

This appliance may be installed in an After-Market* M Permanently Located Manufactured Home, where not prohibited by state or local codes.

* (After Market: Completion of sale, not for purpose of resale from manufacturer).

This appliance is only for use with the type of gas indicated on rating plate. This appliance is not convertible for use with other gases.

NOTE: See “Producing Adequate Air For Combustion And Ventilation” page 26.

CHOOSING THE LOCATION FOR YOUR FIREPLACE:

The figure below shows some of many ways your fireplace may be installed. Consider traffic pattern in your room and location of doors and windows. Moving air from ceiling fans, open doors and hot air grills may cause flames to soot. If a disturbance is found that affects flames, it must be eliminated by turning off ceiling fan, closing door or closing or moving hot air register. A corner location may be best where space is limited.

Your fireplace weighs no more than some of your fine furniture. If fireplace is located near a load bearing wall, additional supports to foundation will not be necessary. **HEAVY FACINGS, SUCH AS BRICK, STONE, ETC., MAY REQUIRE ADDITIONAL FOUNDATION SUPPORT.**

NOTE: If this appliance is installed directly on carpeting, tile or other combustible material, other than wood flooring, appliance shall be installed on a metal or wood panel extending full width and depth of appliance.

The Manufacturers Trim Kit must be used for Zero Clearance Installation.

1. Set top (long) trim panel in place on top of unit. The panel should be flat against outside face of fireplace, and standing vertically (measuring approximately 12” from rear of unit to front area). Mark along lower edge of trim panel with a pencil to make reference line for mounting.
2. Set side panels in place, flat against fireplace. Mark down inside edge of trim panel to make a vertical reference line.

GAS LINE

Gas supply line and electrical supply must be installed before framing in the fireplace by a licensed installer.

DRAFTS

Do not locate the fireplace in high traffic areas or areas exposed to high drafts and winds. Locate the fireplace away from furniture and draperies.

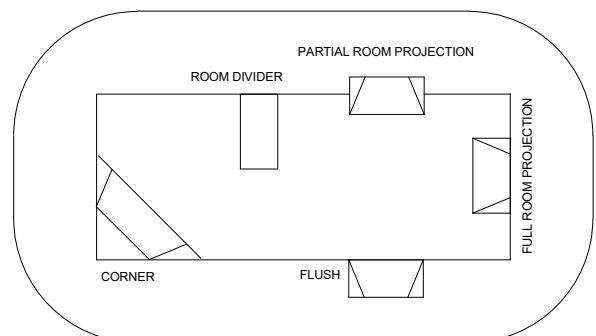

ZERO CLEARANCE STANDOFF(S) ASSEMBLY

NOTE: All Standoff must be attached to the appliance before installing as a Zero Clearance appliance.

Follow the instructions given in the diagrams below exactly.

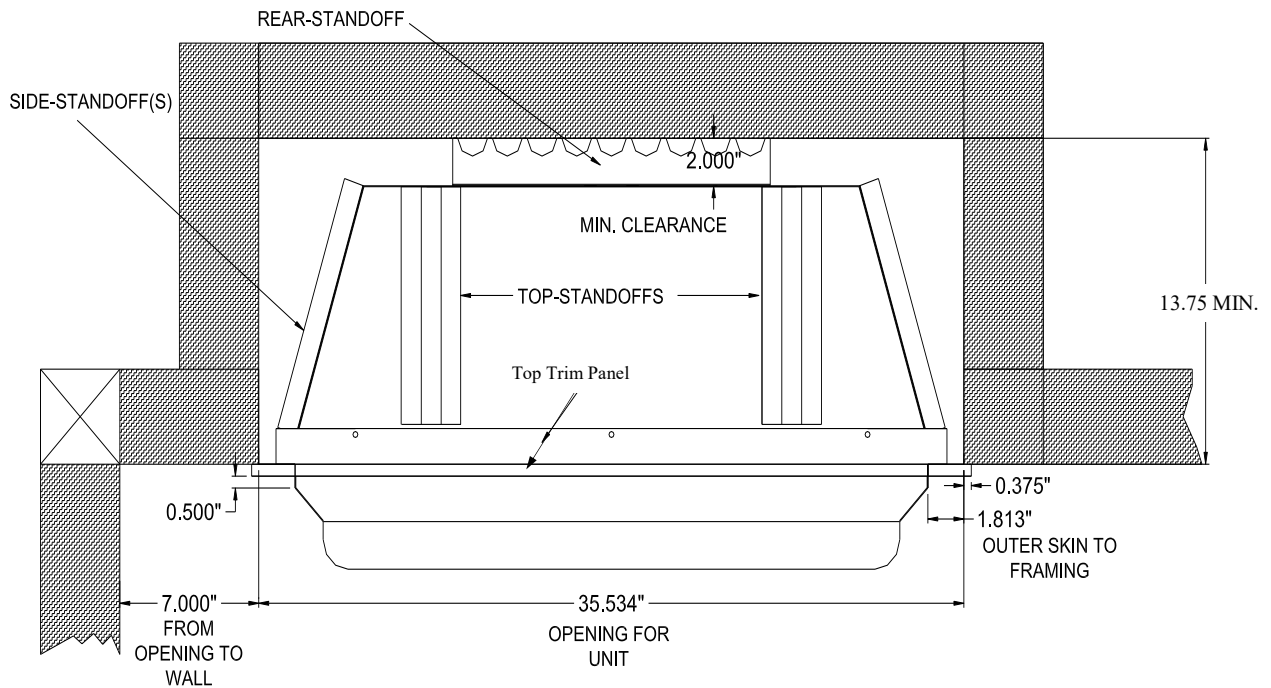
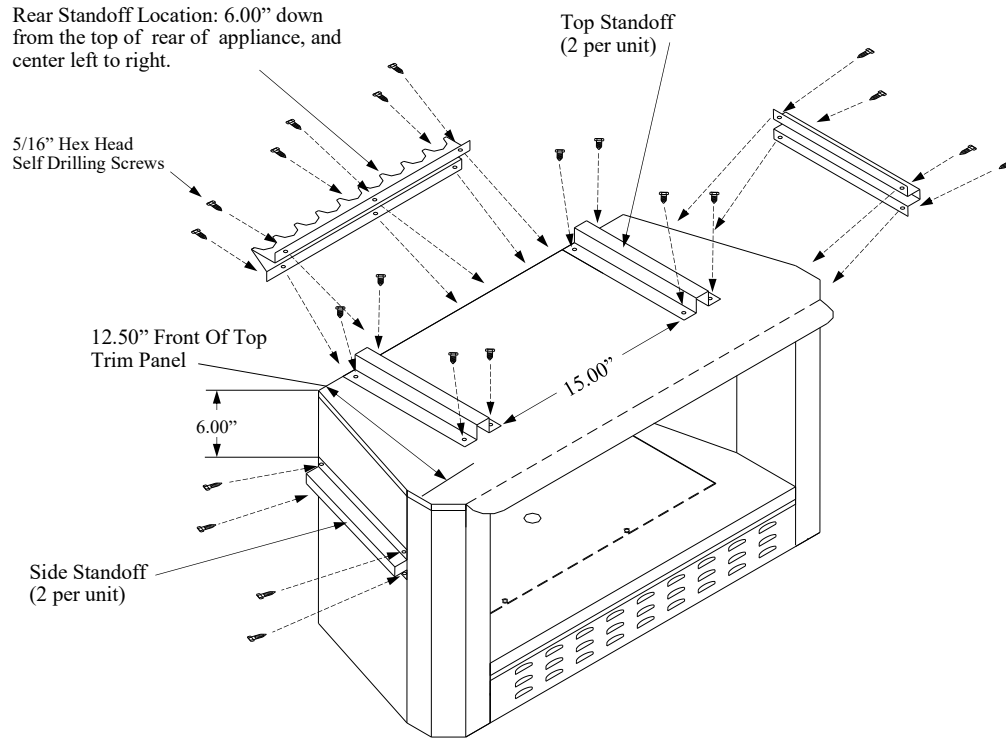

FIREPLACE CLEARANCES (ZC)

Fireplace may be placed directly on a combustible floor, against a combustible wall at marked clearances or on a raised wooden platform.

If fireplace is to be installed on a raised wooden platform, platform must be a continuous level surface. The fireplace must be secured in place so it cannot shift positions. Only header (see below) may rest on standoffs on top of firebox. When the firebox is installed over carpeting, vinyl tile, or any combustible material other than wood flooring, it must be installed on a metal or wood panel extending its full width and depth. Alternatively, carpeting, vinyl tile, etc. may be removed beneath fireplace before installing.

COMBUSTIBLE MATERIALS MUST NOT BE INSTALLED OVER OR TOUCH ANY BLACK PAINTED SURFACE. DO NOT BLOCK HEAT CIRCULATING AIR OUTLETS. DOING SO MAY RESULT IN POTENTIAL FIRE HAZARDS.

1. **Sidewall Clearances:** Clearances from side of fireplace opening to any adjacent combustible wall should not be less than 7" right side and 7" left side.
2. **Ceiling Clearances:** Ceiling height should not be less than 26" from top of fireplace opening.

INSTALLING FIREBOX (ZC)

This list of specific instructions will help you make certain that every installation operation is performed correctly. Complete installation steps in sequence shown.

LOCAL BUILDING CODES SHOULD BE CONSULTED IN ALL CASES AS TO PARTICULAR REQUIREMENTS CONCERNING INSTALLATION OF FACTORY BUILT FIREPLACES. Select location for fireplace by taking into consideration factors previously outlined in "Choosing the Location."

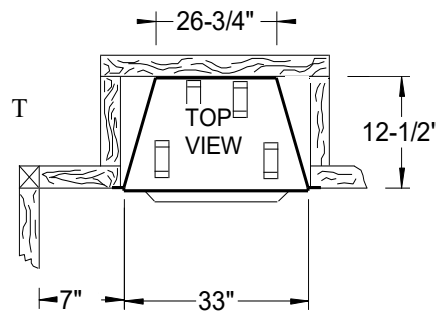

Framing Firebox

Width of framed opening must be 35-17/32".

Height of framed opening must be 25 1/8".

Entire fireplace can be elevated above floor to achieve a raised hearth effect. This can be done by adding a small platform to achieve desired height.

NOTE: Wiring for lower blower must be installed during framing stage. Insulation should be used in framing on back, sides, and top.

Install Firebox

Install firebox into framed opening by placing it directly in front of opening and sliding it into proper position. Please follow wooden surround instructions. (Also see page 25)

Level Firebox

Check level of the firebox on top edge of fireplace face. Shim if necessary.

WARNING: Installation and repairs should be performed by a qualified service person. The appliance should be inspected before use and at least annually by a professional service person. More frequent cleaning may be required due to excessive lint from carpeting, bedding material, pet hair, etc. It is imperative that control compartments, burners and circulating air passageways of appliance be kept clean.

FINISHING YOUR FIREPLACE (ZC)

There is a wide variety of finishing material available for your fireplace from formal wall treatments with marble and mantels, to rustic wood paneling, stone or brick. Non-combustible materials used in this installation such as slate, tile, marble, etc. must be at least 1/2" thick.

IT IS IMPORTANT THAT BLACK FACE OF FIREPLACE NOT BE COVERED WITH ANY TYPE OF COMBUSTIBLE MATERIAL.

Check to see whether man-made brick and stone are made of non-combustible materials before using them on face of fireplace. Some of these products contain combustible materials. Combustible wall coverings such

as paneling or wall-board may not overlap black face of fireplace. Space between wall covering and fireplace should be sealed with a heat resistant material such as rock wool insulation or mortar.

NOTE: An "L" shaped steel lintel must be installed across top of firebox opening where facing materials such as brick or stone is used on the face of firebox. It acts as a support/ firestop. It should be attached to face of fireplace with screws and sealed to fireplace with a heat-resistant sealer.

CLEARANCES (ZC)

To ensure a safe installation, following must be carefully observed.

1. **Sidewall Clearances:** Clearances from side of fireplace opening to any adjacent combustible wall should not be less than 7".
2. **Ceiling Clearances:** Ceiling height should not be less than 26" from the top of fireplace opening.
3. **Mantel Clearances:** Clearance from top of heater to mantel or mantel supports should not be less than 20".
4. **Floor Clearances:** No clearance is required if the appliance is installed per these instructions.

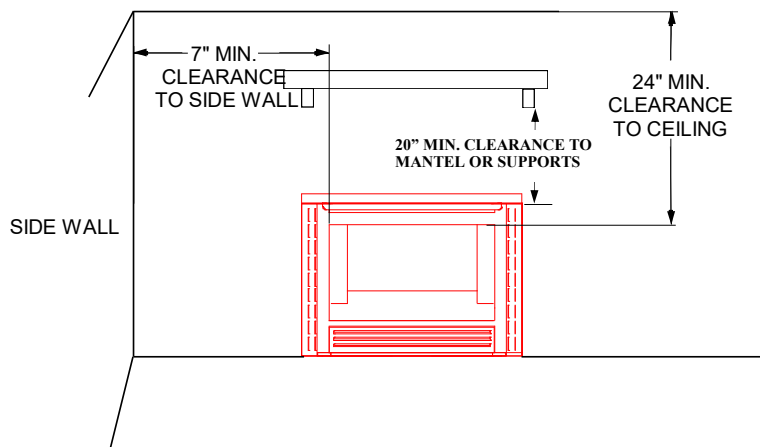

SECTION VI

MODEL 384 (FS) FREESTANDING INSTALLATION

(1) Determine exact position of your gas heater.

NOTE: Due to high temperatures, this heater should be located out of traffic areas and away from furniture and draperies.

NOTE: For safe installation the minimum clearances must be met. See Figure below.

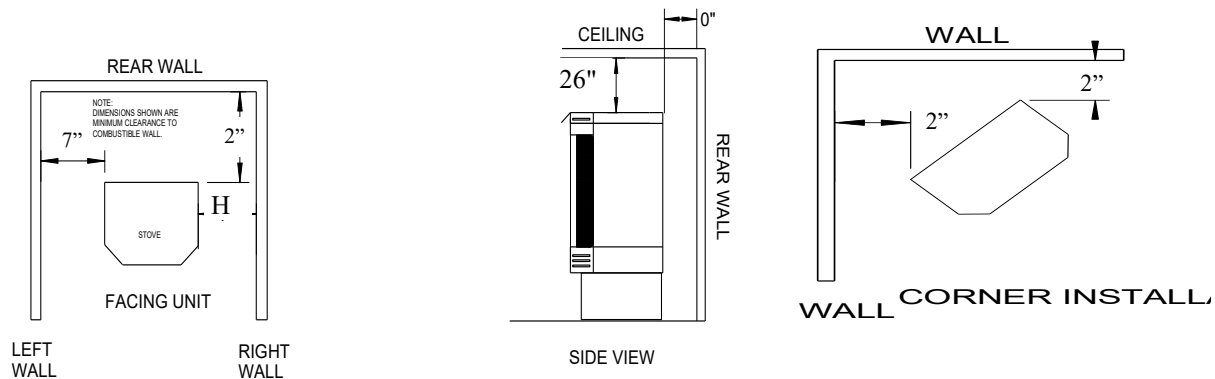

CAUTION: The installation must conform with local codes or in absence of local codes, with *National Fuel Gas Code, ANSI Z223.1/NFPA54*.

NOTE: See page 5 for Gas Connection and Pressure Check.

(2) Make sure you have right valve for your type of gas. Check label on side of valve. Position logs as shown in Log Placement Section, Pages 6-7. Position screen before leaving heater unattended.

This appliance is only for use with type of gas indicated on rating plate.

This appliance is not convertible for use with other gases.

WARNING: Young children should be carefully supervised when they are in same room with appliance. Children and adults should be alerted to hazards of high surface temperature and should stay away to avoid burns or clothing ignition.

WARNING: When appliance is installed directly on carpeting, tile or other combustible material, other than wood flooring, appliance shall be installed on a metal or wood panel extending full width and depth of appliance.

FREESTANDING PEDESTAL OR LEGS INSTALLATION

1. The Model 384 can be mounted as free standing with either a pedestal or Queen Anne legs.
 - A. To mount pedestal Part No.(FA P14) to heater lay heater on its back (use a drop-cloth to protect back of heater and surface of your flooring). Place pedestal against bottom of heater. Center pedestal from left to right and from front to back. Mark holes on angle on top of pedestal. Lay pedestal aside and drill holes in bottom. Replace the pedestal and secure with the provided screws.
 - B. For legs kit Part No.(FA FS384) place heater on its back. Your heater is equipped with four leg mounting nuts. Place a leg at each nut and secure leg with bolts provided. The legs are equipped with leveling bolts needed for leveling adjustments.

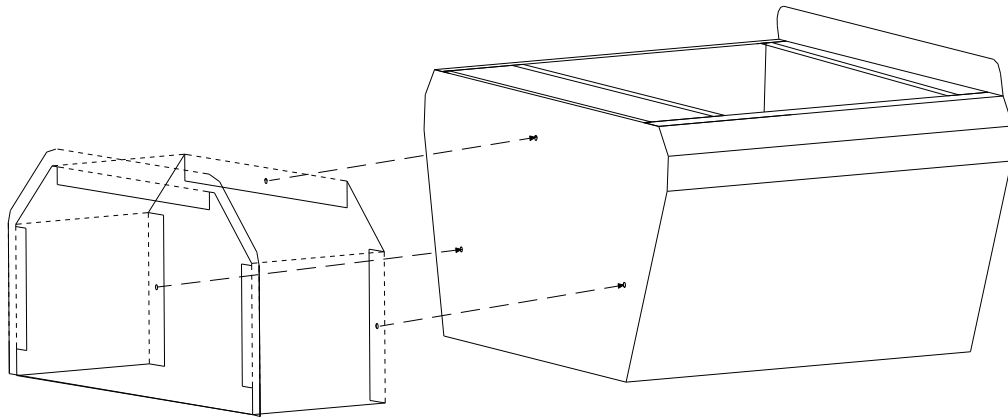

2. Stand heater to upright position. Place heater in desired location. At this point you may want to secure pedestal to floor with screws or an “ell” bracket.
3. Hook up gas supply line. Check for leaks with mild soapy water. See page 5 Installation Clearances and Gas Connection.

SECTION VII
MODEL 384 (FS)
ALCOVE INSTALLATION

CAUTION: READ ENTIRE MANUAL BEFORE INSTALLING HEATER.

- (1) For clearances, see Figure below. The minimum must be met.
- (2) For Installation and Gas Hookup Connection see page 5.

CAUTION: The installation must conform with local codes, or in absence of local codes, with *National Fuel Gas Code, ANSI Z223.1/NFPA54.*

WARNING: DO NOT USE THIS HEATER IF ANY PART HAS BEEN UNDER WATER. IMMEDIATELY CALL A QUALIFIED SERVICE TECHNICIAN TO INSPECT ROOM HEATER AND TO REPLACE ANY PART OF CONTROL SYSTEM AND GAS CONTROL WHICH HAS BEEN UNDER WATER.

WARNING: IMPROPER INSTALLATION, ADJUSTMENT, ALTERATION, SERVICE OR MAINTENANCE CAN CAUSE PROPERTY DAMAGE, PERSONAL INJURY OR LOSS OF LIFE. REFER TO THIS MANUAL.

WARNING: ANY CHANGE TO THIS HEATER OR ITS CONTROLS CAN BE DANGEROUS.

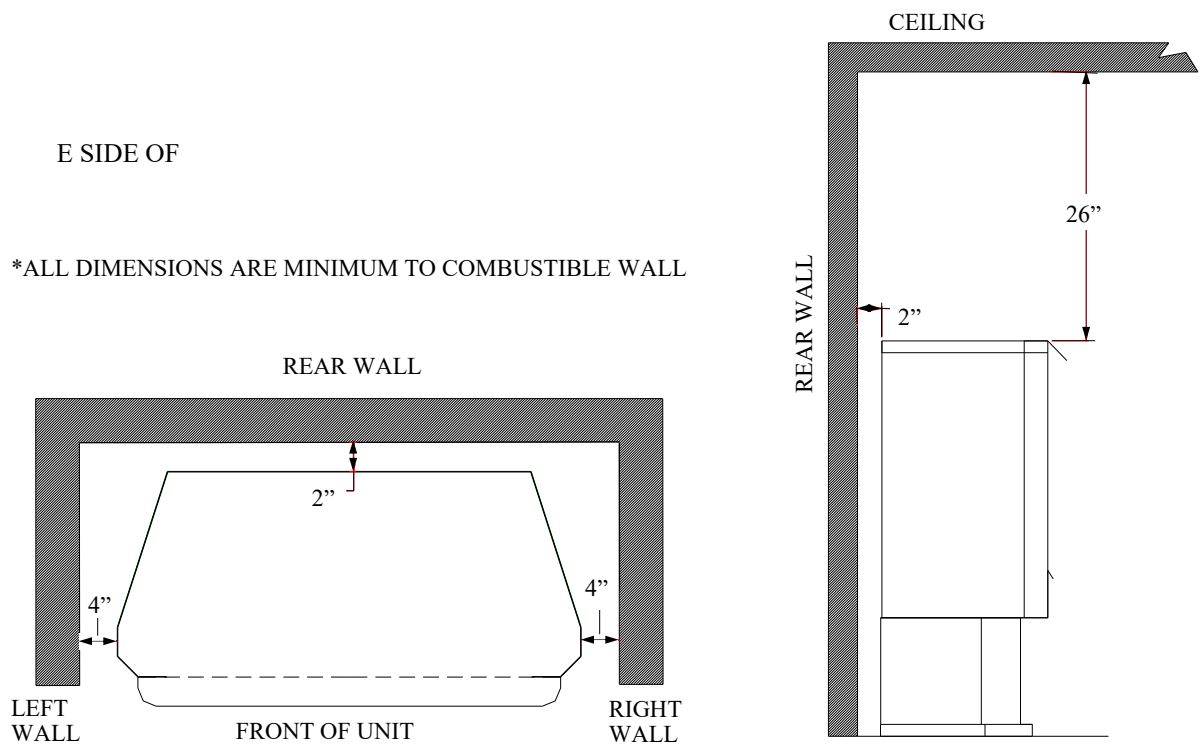

SECTION VIII—PRODUCING ADEQUATE AIR FOR COMBUSTION AND VENTILATION

This section is for residential or permanently located manufactured home installation

This heater shall not be installed in unusually tight construction unless provisions are adequate for combustion and ventilation air.

NOTE: This heater shall not be installed in a room or space unless the required volume of indoor combustion air is provided by the method in *National Fuel Gas Code, ANSIZ223.1/NFPA 54*, the *International Fuel Gas Code*, or applicable codes.

National Fuel Gas Code, ANSI Z223.1/NFPA 54 defines unusually tight construction or unconfined space as a space whose volume is less than 50 cubic feet per 1,000 BTU per hour (4.8m³ per kw) of aggregate input rating of all appliances installed in that space and an unconfined space as a space whose volume is not less than 50 cubic feet per 1,000 BTU per hour (4.8m³ per kw) of aggregate input rating of all appliances installed in that space. Rooms communicating directly with space in which appliances are installed, through openings not furnished with doors, are considered a part of unconfined space.

WARNING: IF AREA IN WHICH HEATER MAY BE OPERATED DOES NOT MEET THE REQUIRED VOLUME FOR INDOOR COMBUSTION AIR, COMBUSTION AND VENTILATION AIR SHALL BE PROVIDED BY ONE OF METHODS DESCRIBED IN NATIONAL FUEL GAS CODE, ANSI Z223.1/NFPA 54, THE INTERNATIONAL FUEL GAS CODE OR APPLICABLE CODES.

WARNING: IF AREA IN WHICH HEATER MAY BE OPERATED IS SMALLER THAN THAT DEFINED AS AN UNCONFINED SPACE OR IF BUILDING IS OF UNUSUALLY TIGHT CONSTRUCTION, PROVIDE ADEQUATE AIR FOR COMBUSTION AND VENTILATION BY ONE OF METHODS DESCRIBED IN NATIONAL FUEL GAS CODE, ANSI Z223.1/NFPA 54 AIR FOR COMBUSTION AND VENTILATION OR APPLICABLE LOCAL CODES.

Unusually tight construction is defined as construction where:

- a) Walls and ceilings exposed to the outside atmosphere have a continuous water vapor retarder with a rating of 1 perm (6 x 10⁻¹¹ kg per pa-sec-m²) or less with openings gasketed or sealed.
- b) Weather stripping has been added on openable windows and doors.
- c) Caulking or sealants are applied to areas such as joints around window and door frames, between sole plates and floors, between wall-ceiling joints, between wall panels, at penetrations for plumbing, electrical and gas lines and at other openings.

NOTE: SOME AREAS IN THE UNITED STATES HAVE HIGHER REQUIREMENTS FOR CUBIC FEET PER 1000 BTU/ HOUR INPUT. (EX. CINCINNATI, OHIO CODES REQUIRE 70 CUBIC FEET). CHECK YOUR LOCAL CODE BEFORE INSTALLATION.

DETERMINING FRESH-AIR FLOW FOR HEATER LOCATION

DETERMINE IF YOU HAVE UNUSUALLY TIGHT CONSTRUCTION OR UNCONFINED SPACE

Use this worksheet to determine if you have unusually tight construction or unconfined space.

SPACE: Includes the room in which you will install heater plus adjoining rooms with doorless passageways or ventilation grills between the rooms.

1. Determine the volume of the space (length x width x height).

Length x Width x Height = _____ cu.ft.(volume of space)

EXAMPLE: 20 ft.(Length) x 16 ft.(Width) x 8 ft.(ceiling Height)=
2560 cu. ft. (volume of space)

If additional ventilation to adjoining room is supplied with grills or openings, add the volume of these rooms to the total volume of the space.

2. Divide the space volume by 50 cubic feet to determine the maximum BTU/Hr the space can support.

_____ (volume of space)/50 cu. ft. =maximum BTU/Hr the space can support

EXAMPLE: 2560 cu. ft. (volume of space /50 cu. Ft. = 51.2 or
51200 (maximum BTU/Hr the space can support)

3. Add the BTU/Hr of all fuel burning appliances in the space.

Vent-free heater		_____ BTU/Hr
*Gas water heater		_____ BTU/Hr
Gas furnace		_____ BTU/Hr
Vented gas heater		_____ BTU/Hr
Gas fireplace logs		_____ BTU/Hr
Other gas appliances	+	_____ BTU/Hr
Total	=	_____ BTU/Hr

Example: Gas water heater 40000 BTU/Hr
Vent-free heater + 18000 BTU/Hr
Total = 58000 BTU/Hr

*Does not include direct-vent gas appliances. Direct-vent draws combustion air from outdoors and vents to the outdoors.

4. Compare the maximum BTU/Hr the space can support with actual amount of BTU/Hr used.

_____ BTU/Hr (maximum the space can support)
_____ BTU/Hr (actual amount of BTU/Hr used)

Example: 51200 BTU/Hr (maximum the space can support)
58000 BTU/Hr (actual amount of BTU/Hr used)

Space in above example is unusually tight construction because actual BTU/Hr used is more than maximum BTU/Hr the space can support. You must provide additional fresh air. Your options are as follows:

- A. Rework worksheet, adding space of an adjoining room. If extra space provides an unconfined space, remove door to adjoining room or add ventilation grills between rooms. See "Air For Combustion And Ventilation Inside Building", page 33.
- B. Vent room directly to the outdoors. See "Air For Combustion And Ventilation Outdoors", page 34.
- C. Install a lower BTU/Hr heater, if lower BTU/Hr size makes room unconfined.

If actual BTU/Hr used is less than the maximum BTU/Hr the space can support, space is an unconfined space. You will need no additional fresh air ventilation.

WARNING: YOU MUST PROVIDE ADDITIONAL VENTILATION AIR IN UNUSUALLY TIGHT CONSTRUCTION.

SECTION IX

AIR FOR COMBUSTION AND VENTILATION INSIDE BUILDING

This fresh air would come from an adjoining unconfined space. When venting to an adjoining space, you must provide two permanent openings: one within 12" of ceiling and one within 12" of floor, on wall connecting two spaces. (See Options 1 and 2 below.) You can also remove door into adjoining room. (See Option 3 below.)

WARNING

REWORK WORKSHEET, ADDING SPACE OF ADJOINING UNCONFINED SPACE. COMBINED SPACES MUST HAVE ADEQUATE AMOUNT OF AIR TO SUPPLY ALL APPLIANCES IN BOTH SPACES.

NOTE: Each opening shall have a minimum free area of 1 square inch per 1000 BTU's per hour of the total input ratings of all gas utilization equipment in the confined space, but not less than 100 square inches.

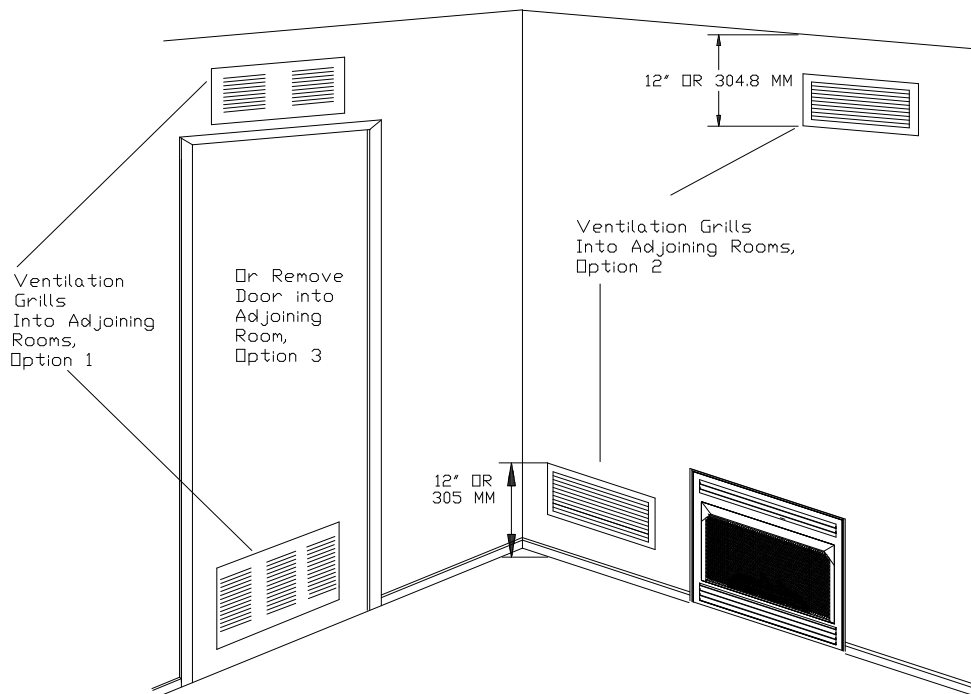

Ventilation Air From Inside Building



WARNING

THIS HEATER MUST HAVE ADEQUATE AMOUNT OF AIR FOR PROPER OPERATION. IF NOT, POOR FUEL COMBUSTION COULD RESULT. READ THE FOLLOWING INSTRUCTIONS TO ENSURE PROPER AMOUNT OF AIR FOR THIS AND OTHER FUEL-BURNING APPLIANCES IN YOUR HOME.

SECTION X AIR FOR COMBUSTION AND VENTILATION OUTDOORS

Provide extra fresh air by using ventilation grills or ducts. You must provide two permanent openings: one within 12" of ceiling and one within 12" of floor. These spaces include attics and crawl spaces. Follow **National Fuel Gas Code NFPA 54/ANSI Z223.1**, Section 5.3, "Air For Combustion and Ventilation" for required size of ventilation grills or ducts.

IMPORTANT: Do not provide openings for inlet air into attic if attic has a thermostat-controlled power vent. Heated air entering the attic will activate the power unit.

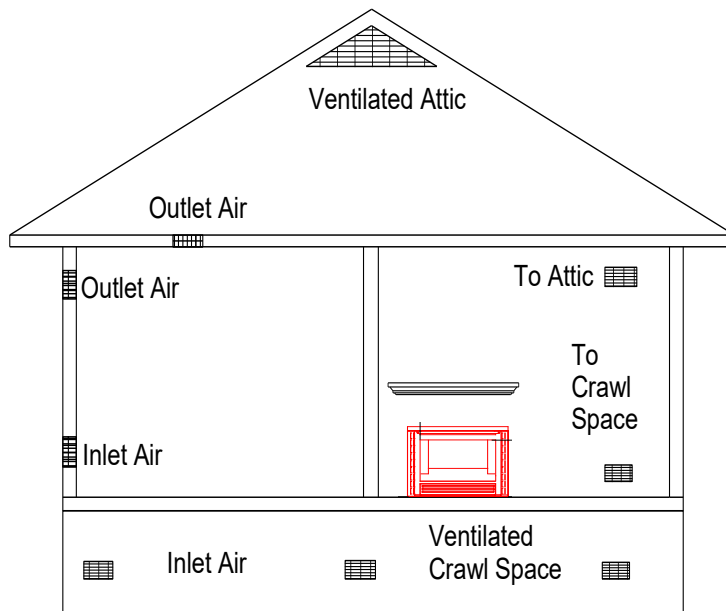

Ventilation Air From Outdoors

SECTION XI
INSTALLATION AFTER MARKET
PERMANENTLY LOCATED MANUFACTURED HOME

NOTE: See “Producing Adequate Air For Combustion And Ventilation” page 26.

THIS APPLIANCE MAY BE INSTALLED IN AN AFTERMARKET*, PERMANENTLY LOCATED, MANUFACTURED HOME, WHERE NOT PROHIBITED BY LOCAL CODES.

*After Market: Completion of sale, not for purpose of resale from manufacturer.

THIS APPLIANCE IS ONLY FOR USE WITH TYPE OF GAS INDICATED ON RATING PLATE. THIS APPLIANCE IS NOT CONVERTIBLE FOR USE WITH OTHER GASES.

NOTE: For permanently located manufactured home installation follow “Installation”, page’s 5-30.

NOTE: See “Producing Adequate Air for Combustion And Ventilation” page 26.

IMPORTANT SAFEGUARDS

Although your gas logs are very realistic in appearance, it is not a real burning fireplace and must not be used for burning rejected material.

- To avoid irreparable damage to heater or personal injury, matches, paper, garbage or any other material **must not** be placed or thrown on top of logs or into flames.
- To avoid personal injury, do not touch hot surfaces when heater is operating.
- Close supervision is necessary when heater is being operated near children.

WARNING:

THE LOGS ARE MANUFACTURED FROM BONDED CERAMIC FIBER. THIS IS A COMMONLY USED MATERIAL IN INDUSTRY WORLDWIDE. IN EVENT THAT A LOG SHOULD BE REMOVED, CARE SHOULD BE TAKEN NOT TO DAMAGE BONDED MATERIAL. INTENTIONAL MISUSE OR DELIBERATELY FRAGMENTING MATERIAL COULD LEAD TO INHALING FIBERS AND BE HAZARDOUS TO YOUR HEALTH.

THIS HEATER IS INTENDED FOR USE AS A GAS HEATER FIREPLACE AS DESCRIBED IN THESE INSTRUCTIONS. IT SHOULD IT SHOULD NOT BE USED FOR ANY OTHER PURPOSE.

CLEANING

CAUTION: BEFORE CLEANING OR MOVING THESE LOGS OR OTHER PARTS OF HEATER, BE SURE TO READ ABOVE SECTIONS ON “IMPORTANT SAFEGUARDS.”

- Appliance must be turned “OFF” before cleaning inside firebox (burn area), make sure pilot is “OFF” completely and appliance has cooled.
- All cleaning should be carried out when heater is cold. Limited cleaning is required with normal use. Dusting front of base, top of piezo cover or control knob panel may be required occasionally. Do not use cleaning fluids to clean logs or any other part of heater.
- If flames show unusual shapes or behavior or if burner fails to ignite properly, burner holes may require cleaning. If this occurs, contact your nearest dealer to service heater.
- The heater can be cleaned by removing logs. Lift logs gently, as not to damage fiber pieces. The logs have been spot glued in place for shipping, use caution when removing. Lift each log by holding it carefully at each end. Use a vacuum cleaner to remove dust and loose particles from base, logs and around burner and ODS/Pilot. Gloves are recommended to prevent fibers from breaking skin. If skin is broken, clean with soap and water.

WARNING:

Failure to keep the primary air openings (s) of the burner (s) clean may result in sooting and property damage.

TROUBLESHOOTING

WARNING

TURN OFF, UNPLUG HEATER AND LET COOL BEFORE SERVICING. ONLY A QUALIFIED SERVICE PERSON SHOULD SERVICE AND REPAIR HEATER.

CAUTION

NEVER USE A WIRE, NEEDLE OR SIMILAR OBJECT TO CLEAN ODS/PILOT. THIS CAN DAMAGE ODS/PILOT.

OBSERVED PROBLEM	POSSIBLE CAUSE	SOLUTION
Igniter button is pressed No spark at ODS/Pilot	Igniter electrode positioned incorrectly	Replace igniter
	Igniter electrode broken	Replace igniter
	Igniter electrode not connected to igniter cable	Reconnect igniter cable
	Igniter cable pinched or wet	Free igniter cable if pinched by any metal or tubing. Keep igniter cable dry
	Piezo igniter nut is loose	Tighten nut holding piezo igniter to heater cabinet. Nut is located inside heater cabinet at top
	Broken igniter cable	Replace igniter cable
	Bad piezo igniter	Replace piezo igniter
OBSERVED PROBLEM	POSSIBLE CAUSE	SOLUTION
Igniter button is pressed Spark at ODS/Pilot No Ignition	Gas supply turned off or manual shutoff valve is closed	Turn on gas supply or open manual shutoff valve
	Control knob not in "PILOT" position	Turn control knob to "PILOT" position
	Control knob not pressed in while in "PILOT" position	Press in control knob while in "PILOT" position

OBSERVED PROBLEM	POSSIBLE CAUSE	SOLUTION
Igniter button is pressed Spark at ODS/Pilot No Ignition (continued)	Air in gas lines when installed	Continue to hold down control knob. Repeat igniting operation until air is removed.
	Depleted gas supply	Contact local propane gas company
	ODS/Pilot is clogged	Clean ODS/Pilot or replace ODS/Pilot assembly
	Gas regulator setting is not correct	Replace gas regulator

OBSERVED PROBLEM	POSSIBLE CAUSE	SOLUTION
ODS/PILOT lights but flame goes out when control knob is released	Control knob is not fully pressed in	Press control knob completely
	Control knob not pressed in long enough	After ODS/Pilot lights keep control knob pressed thirty (30) seconds
	Safety interlock system has been triggered (if equipped)	Wait one (1) minute for safety interlock system to reset
	Manual shutoff valve not fully open	Fully open manual shutoff valve
	Thermo-couple connection loose at control valve	Hand tighten until snug, then tighten 1/4 turn
	Pilot flame not touching thermo-couple, which allows thermo-couple to cool, causing pilot flame to go out. This problem can be caused by one or both of the following: A) Low gas pressure B) Dirty or partially clogged ODS/Pilot	A) Contact local propane gas company B) Clean ODS/Pilot (See Cleaning and Maintenance) or replace ODS/Pilot assembly
	Control valve damaged	Replace valve control

OBSERVED PROBLEM	POSSIBLE CAUSE	SOLUTION
Burner does not light after ODS/Pilot is lit	Burner orifice is clogged	Clean burner (see Cleaning and Maintenance) or replace burner orifice
	Inlet gas pressure is too low	Contact local propane gas company
Delayed ignition of burner	Manifold pressure is too low	Contact local propane gas company
	Burner orifice is clogged	Clean burner (see Cleaning and Maintenance) or replace burner orifice
Burner backfiring during combustion	Burner orifice is clogged or damaged	Clean burner (see Cleaning and Maintenance) or replace burner orifice
	Burner damaged	Replace burner
	Gas regulator defective	Replace gas regulator
Slight smoke or odor during initial operation	Residues from manufacturing process	Problem will stop after a few hours of operation
Heater produces a whistling noise when burner is lit	Turning control knob to "HI" position when burner is cold (if equipped with this type of valve)	Turn control knob to "LOW" position and allow to warm
	Air in gas line	Operate burner until air is removed from line. Call local propane company to check gas line
	Air passageways on heater blocked	Observe minimum installation clearances
	Dirty or partially clogged burner orifice	Clean burner or replace orifice

WARNING

IF YOU SMELL GAS:

- * **SHUT OFF GAS SUPPLY**
- * **DO NOT TRY TO LIGHT APPLIANCE**
- * **DO NOT TOUCH ANY ELECTRICAL SWITCH; DO NOT USE ANY PHONE IN YOUR BUILDING**
- * **IMMEDIATELY CALL YOUR GAS SUPPLIER FROM A NEIGHBOR'S PHONE. FOLLOW THE GAS SUPPLIER'S INSTRUCTIONS.**
- * **IF YOU CANNOT REACH YOUR GAS SUPPLIER, CALL THE FIRE DEPARTMENT.**

IMPORTANT: Operating heater where impurities in air exist may create odors. Cleaning supplies, paint, paint remover, cigarette smoke, cements and glues, new carpet or textiles, etc. create fumes. These fumes may mix with combustion air and create odors.

OBSERVED PROBLEM	POSSIBLE CAUSE	SOLUTION
Heater produces a clinking/ticking noise just after burner is lit or shut off	Metal expands while heating or contracts while cooling	This is common with most heaters. If noise is excessive, contact a qualified service person
Heater produces unwanted odors	Heater burning vapors from paint, hairspray, glues, etc. (See Important above)	Ventilate room. Stop using odor causing products while heater is running
	Low fuel supply	Refill supply tank
	Gas leak (See WARNING above)	Locate and control all leaks (See Checking Gas Connections)
Heater shuts off in use (ODS operates)	Not enough fresh air is available	Open window/door for ventilation
	Low line pressure	Contact local propane co.
	ODS/Pilot is partially clogged	Clean ODS/Pilot
Gas odor even when control knob is in OFF position	Gas leak (See WARNING above).	Locate and correct all leaks (see Checking Gas Connections)
	Control valve defect	Replace control valve
Gas odor during combustion	Foreign matter between control valve and burner	Remove foreign matter from gas tubing
	Gas leak (See WARNING above)	Locate and correct all leaks (see Checking Gas Connections)

SERVICING

Repair and replacement work should only be performed by a qualified service technician.

Always shut off the gas supply and make sure heater is cool before beginning any service operation. Check for gas leaks after servicing.



REPAIR PARTS



A parts list with exploded view follows. Always include correct name, part number and model number of heater when ordering service parts. Please contact your local dealer or distributor when ordering . If one is not available, you may contact.

New Buck Corporation
200 Ethan Allen Drive
PO Box 69
Spruce Pine, NC 28777

SIT MILLIVOLT VALVE ESB MA344EBBA BASE

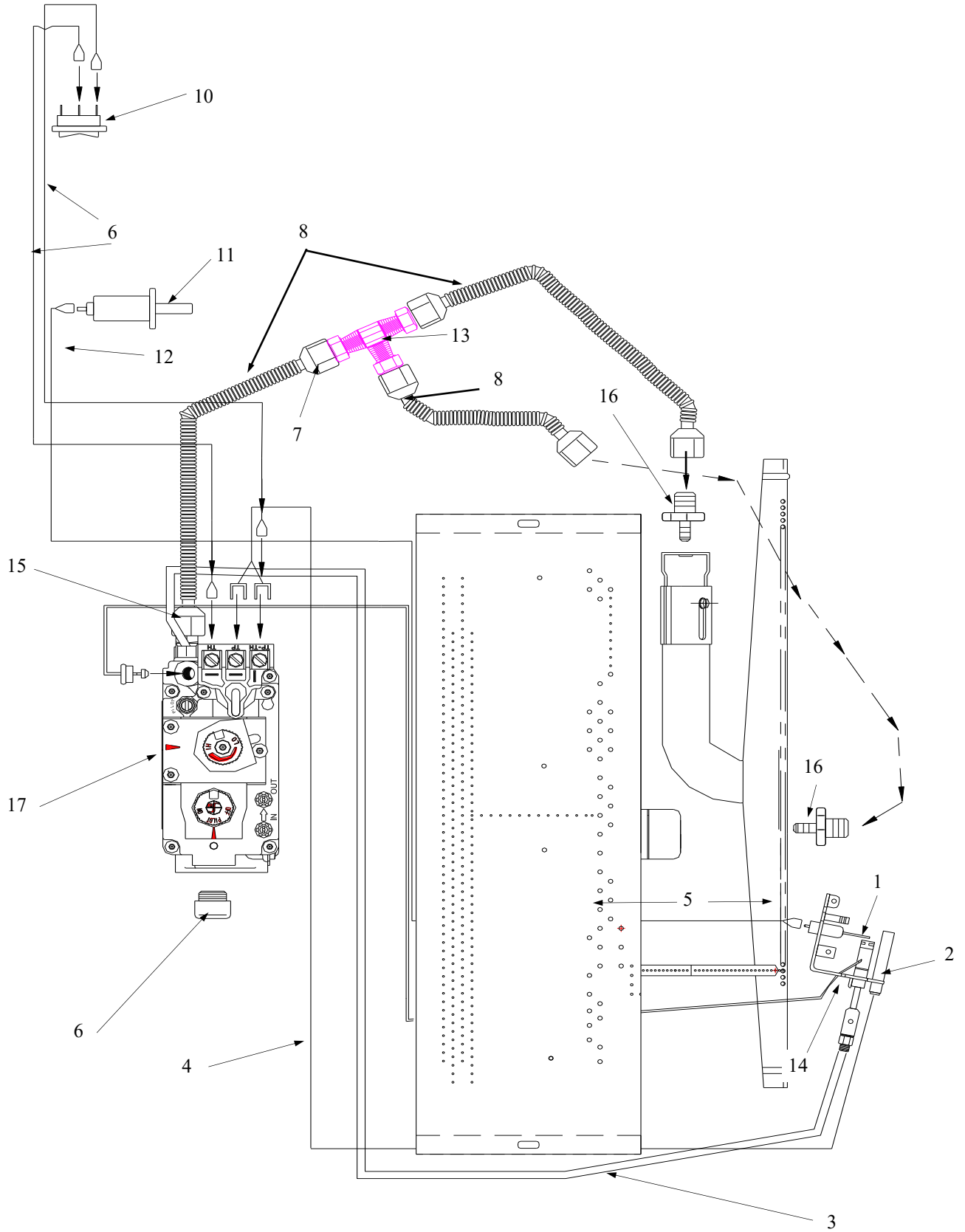

NEW BUCK CORPORATION

We reserve right to amend these specifications at any time without notice. The only warranty applicable is our standard written warranty. We offer no other warranty, expressed or implied.

LIMITED WARRANTY VENT-FREE GAS LOG HEATER

New Buck warrants this product to be free from defects in materials and components for two (2) years from date of first purchase, provided that product has been properly installed, operated and maintained in accordance with all applicable instructions. To make a claim under this warranty Bill of Sale or canceled check must be presented.

This warranty is extended only to original retail purchaser and covers cost of parts required to restore the heater to proper condition. Warranty parts **MUST** be obtained through an authorized Buck Stove dealer and/or New Buck, who will provide original factory replacement parts. Failure to use original factory replacement parts voids this warranty. The heater **MUST** be installed by a qualified installer in accordance with all local codes and instructions furnished with unit.

Warranty does not apply to parts that are not in original condition, normal wear and tear or parts that fail or become damaged as a result of misuse, accidents, lack of proper maintenance or defects caused by improper installation.

WARRANTY DOES NOT COVER:

- Removal and re-installation cost
- Labor costs for replacements or repairs
- Transportation
- Cost of service call to diagnose trouble
- Painted surfaces
- Damage or defect caused by improper installation, accident, misuse, abuse, or alteration

TO FULL EXTENT ALLOWED BY LAW OF JURISDICTION THAT GOVERNS THE SALE OF PRODUCT, THIS EXPRESS WARRANTY EXCLUDES ANY AND ALL OTHER EXPRESSED WARRANTIES AND LIMITS DURATION OF ANY AND ALL WARRANTIES, INCLUDING WARRANTIES OF MERCHANTABILITY AND FITNESS FOR A PARTICULAR PURPOSE TO ONE (1) YEAR FROM DATE OF FIRST PURCHASE. NEW BUCK LIABILITY IS HEREBY LIMITED TO PURCHASE PRICE OF PRODUCT AND NEW BUCK SHALL NOT BE LIABLE FOR ANY OTHER DAMAGES WHATSOEVER INCLUDING INCIDENTAL OR CONSEQUENTIAL DAMAGES.

Some states do not allow a limitation on how long an implied warranty lasts or an exclusion or limitation of incidental or consequential damages so above limitation on implied warranties or exclusion on damages may not apply to you.

This warranty gives you specific legal rights. Other rights may vary from state to state.

OWNER REGISTRATION

The attached owner registration card must be completed in its entirety and mailed within 30 days from date of installation in order for warranty coverage to begin to:

New Buck Corporation
P.O. Box 69
Spruce Pine, NC 28777
Email: info@buckstove.com

PLEASE NOTE: Owner Registration Card must contain Authorized Buck Stove Dealer Number and Certified Installer's number (if applicable) for warranty coverage to begin.

NAME: _____
ADDRESS: _____
CITY: _____
STATE: _____ ZIP: _____
CUSTOMER EMAIL: _____
MODEL #: FP-384 SERIAL #: _____
DATE OF INSTALLATION: _____
INSTALLER'S NAME: _____
PURCHASED FROM: _____